

ETSI EN 303 687 V1.1.1 (2023-06)



**6 GHz WAS/RLAN;
Harmonised Standard for access to radio spectrum**



Reference

DEN/BRAN-230021

Keywords

access, broadband, LAN, radio, regulation, testing

ETSI

650 Route des Lucioles
F-06921 Sophia Antipolis Cedex - FRANCE

Tel.: +33 4 92 94 42 00 Fax: +33 4 93 65 47 16

Siret N° 348 623 562 00017 - APE 7112B
Association à but non lucratif enregistrée à la
Sous-Préfecture de Grasse (06) N° w061004871

Important notice

The present document can be downloaded from:

<https://www.etsi.org/standards-search>

The present document may be made available in electronic versions and/or in print. The content of any electronic and/or print versions of the present document shall not be modified without the prior written authorization of ETSI. In case of any existing or perceived difference in contents between such versions and/or in print, the prevailing version of an ETSI deliverable is the one made publicly available in PDF format at www.etsi.org/deliver.

Users of the present document should be aware that the document may be subject to revision or change of status.

Information on the current status of this and other ETSI documents is available at

<https://portal.etsi.org/TB/ETSIDeliverableStatus.aspx>

If you find errors in the present document, please send your comment to one of the following services:

<https://portal.etsi.org/People/CommitteeSupportStaff.aspx>

If you find a security vulnerability in the present document, please report it through our
Coordinated Vulnerability Disclosure Program:

<https://www.etsi.org/standards/coordinated-vulnerability-disclosure>

Notice of disclaimer & limitation of liability

The information provided in the present deliverable is directed solely to professionals who have the appropriate degree of experience to understand and interpret its content in accordance with generally accepted engineering or other professional standard and applicable regulations.

No recommendation as to products and services or vendors is made or should be implied.

In no event shall ETSI be held liable for loss of profits or any other incidental or consequential damages.

Any software contained in this deliverable is provided "AS IS" with no warranties, express or implied, including but not limited to, the warranties of merchantability, fitness for a particular purpose and non-infringement of intellectual property rights and ETSI shall not be held liable in any event for any damages whatsoever (including, without limitation, damages for loss of profits, business interruption, loss of information, or any other pecuniary loss) arising out of or related to the use of or inability to use the software.

Copyright Notification

No part may be reproduced or utilized in any form or by any means, electronic or mechanical, including photocopying and microfilm except as authorized by written permission of ETSI.

The content of the PDF version shall not be modified without the written authorization of ETSI.

The copyright and the foregoing restriction extend to reproduction in all media.

© ETSI 2023.
All rights reserved.

Contents

Intellectual Property Rights	8
Foreword.....	8
Modal verbs terminology.....	9
Introduction	9
1 Scope	10
2 References	10
2.1 Normative references	10
2.2 Informative references.....	11
3 Definition of terms, symbols and abbreviations.....	12
3.1 Terms.....	12
3.2 Symbols.....	13
3.3 Abbreviations	14
4 Technical requirements specifications	15
4.1 Environmental profile.....	15
4.2 Equipment categories	15
4.2.1 Description of categories	15
4.2.2 LPI category.....	15
4.2.3 VLP category	15
4.3 Conformance requirements	16
4.3.1 Nominal centre frequencies and nominal bandwidth.....	16
4.3.1.1 General	16
4.3.1.2 Definition	16
4.3.1.3 Limits	16
4.3.1.4 Conformance.....	16
4.3.2 RF output power	16
4.3.2.1 Definition	16
4.3.2.2 Limits	17
4.3.2.3 Conformance.....	17
4.3.3 Power Spectral Density.....	17
4.3.3.1 Definition	17
4.3.3.2 Limits	17
4.3.3.3 VLP NB usage with a PSD above 1 dBm/MHz	17
4.3.3.4 Conformance.....	17
4.3.4 Transmitter unwanted emissions.....	18
4.3.4.1 Transmitter unwanted emissions in the out-of-band domain	18
4.3.4.1.1 Definition.....	18
4.3.4.1.2 Limits	18
4.3.4.1.3 Conformance	18
4.3.4.2 Transmitter unwanted emissions in the spurious domain.....	18
4.3.4.2.1 Definition.....	18
4.3.4.2.2 Limits	18
4.3.4.2.3 Conformance	19
4.3.4.3 Transmitter unwanted emissions within the 6 GHz WAS/RLAN band	19
4.3.4.3.1 Definition.....	19
4.3.4.3.2 Limits	19
4.3.4.3.3 Conformance	21
4.3.5 Receiver spurious emissions	22
4.3.5.1 Definition	22
4.3.5.2 Limits	22
4.3.5.3 Conformance.....	22
4.3.6 Channel access mechanism.....	22
4.3.6.1 Applicability.....	22
4.3.6.2 Definition	22
4.3.6.3 Requirements and limits.....	22

4.3.6.3.1	Channel access mechanism for Frame Based Equipment (FBE).....	22
4.3.6.3.2	Channel access mechanism for Load Based Equipment (LBE)	24
4.3.6.3.3	ED Threshold level (Energy Detection Threshold level, FBE and LBE).....	29
4.3.6.3.4	Short Control Signalling transmissions (FBE and LBE)	30
4.3.6.4	Conformance.....	30
4.3.7	Receiver blocking	30
4.3.7.1	Definition	30
4.3.7.2	Performance criteria	30
4.3.7.3	Limits	30
4.3.7.4	Conformance.....	31
4.3.8	Receiver selectivity.....	31
4.3.8.1	Definition	31
4.3.8.2	Performance criteria	32
4.3.8.3	Limits	32
4.3.8.4	Conformance.....	32
4.3.9	Mechanical and electrical design	32
4.3.9.1	Power feeding	32
4.3.9.1.1	Description of types of power supply	32
4.3.9.1.2	Wired power connection equipment.....	33
4.3.9.2	Antenna design.....	33
4.3.9.2.1	Description of types of antenna design.....	33
4.3.9.2.2	Integral antenna	33
4.3.9.3	Conformance.....	33
4.3.10	User Access Restrictions	33
4.3.10.1	Definition	33
4.3.10.2	Requirements	33
4.3.10.3	Conformance.....	33
5	Testing for compliance with technical requirements.....	34
5.1	Environmental conditions for testing	34
5.1.1	Introduction.....	34
5.1.2	Normal test conditions	34
5.1.2.1	Normal temperature and humidity	34
5.1.2.2	Normal power source	34
5.1.3	Extreme test conditions.....	34
5.2	Interpretation of the measurement results	34
5.3	Definition of other test conditions	35
5.3.1	Test sequences	35
5.3.2	Test channels	35
5.3.3	Antennas	36
5.3.3.1	Integrated and dedicated antennas.....	36
5.3.3.2	Transmit operating modes.....	36
5.3.3.2.1	Operating mode 1 (single antenna).....	36
5.3.3.2.2	Operating mode 2 (multiple antennas, no beamforming)	37
5.3.3.2.3	Operating mode 3 (multiple antennas, with beamforming).....	37
5.3.4	Presentation of equipment	37
5.3.5	Measurement methods	37
5.4	Essential radio test suites.....	38
5.4.1	Product information	38
5.4.2	Nominal centre frequencies	39
5.4.2.1	Test conditions	39
5.4.2.2	Test methods	39
5.4.2.2.1	Conducted measurement.....	39
5.4.2.2.2	Radiated measurement.....	40
5.4.2.2.3	Test fixture measurement	40
5.4.3	RF output power	40
5.4.3.1	Test conditions	40
5.4.3.2	Test methods	41
5.4.3.2.1	Conducted measurement.....	41
5.4.3.2.2	Radiated measurement.....	42
5.4.3.2.3	Test fixture measurement	43
5.4.4	Power Spectral Density.....	43

5.4.4.1	Test conditions	43
5.4.4.2	Test methods	43
5.4.4.2.1	Conducted measurement.....	43
5.4.4.2.2	Radiated measurement.....	46
5.4.4.2.3	Test fixture measurement	46
5.4.5	Transmitter unwanted emissions outside the 6 GHz WAS/RLAN band	46
5.4.5.1	Test conditions	46
5.4.5.2	Test method.....	46
5.4.5.2.1	Conducted measurement.....	46
5.4.5.2.2	Radiated measurement.....	49
5.4.5.2.3	Test fixture measurement	49
5.4.6	Transmitter unwanted emissions within the 6 GHz WAS/RLAN band.....	49
5.4.6.1	Test conditions	49
5.4.6.2	Test method.....	49
5.4.6.2.1	Conducted measurement.....	49
5.4.6.2.2	Radiated measurement.....	51
5.4.6.2.3	Test fixture measurement	51
5.4.7	Receiver spurious emissions	51
5.4.7.1	Test conditions	51
5.4.7.2	Test methods	52
5.4.7.2.1	Conducted measurement.....	52
5.4.7.2.2	Radiated measurement.....	54
5.4.7.2.3	Test fixture measurement	54
5.4.8	Channel access mechanism.....	54
5.4.8.1	Test conditions	54
5.4.8.2	Test method for FBE.....	54
5.4.8.2.1	Additional test conditions	54
5.4.8.2.2	Conducted measurements	54
5.4.8.2.3	Generic test procedure for measuring channel/frequency usage	58
5.4.8.2.4	Radiated measurements	58
5.4.8.2.5	Test fixture measurement	59
5.4.8.3	Test method for LBE.....	59
5.4.8.3.1	Additional test conditions	59
5.4.8.3.2	Conducted measurements	59
5.4.8.3.3	Generic test procedure for measuring channel/frequency usage	67
5.4.8.3.4	Radiated measurements	67
5.4.8.3.5	Test fixture measurement	68
5.4.9	Receiver blocking	68
5.4.9.1	Test conditions	68
5.4.9.2	Test methods	68
5.4.9.2.1	Conducted measurement.....	68
5.4.9.2.2	Radiated measurement.....	69
5.4.9.2.3	Test fixture measurement	69
5.4.10	Receiver selectivity.....	70
5.4.10.1	Test conditions	70
5.4.10.2	Test methods	70
5.4.10.2.1	Conducted measurement.....	70
5.4.10.2.2	Radiated measurements	71
5.4.10.2.3	Test fixture measurement	71
5.4.11	Mechanical and electrical design	72
5.4.12	VLP NB operation with a PSD exceeding 1 dBm/MHz	72
5.4.12.1	Test conditions	72
5.4.12.2	Test methods	72
5.4.12.2.1	Conducted measurements	72
5.4.12.2.2	Radiated measurements	73
5.4.12.2.3	Test fixture measurement	73
5.4.13	Assessment procedure for UAR.....	74
5.4.13.1	Introduction.....	74
5.4.13.2	Test conditions	74
5.4.13.3	Test Method	74

Annex A (informative):	Relationship between the present document and the essential requirements of Directive 2014/53/EU	75
Annex B (normative):	Test sites and arrangements for radiated measurements.....	77
B.1	Introduction	77
B.2	Radiated test sites	77
B.2.1	Open Area Test Site (OATS)	77
B.2.2	Semi Anechoic Room (SAR)	78
B.2.3	Fully Anechoic Room (FAR)	79
B.2.4	Measurement distance	80
B.3	Antennas	81
B.3.1	Introduction	81
B.3.2	Measurement antenna.....	81
B.3.3	Substitution antenna	81
B.4	Test fixture	81
B.4.1	Introduction	81
B.4.2	Description of the test fixture	82
B.4.3	Using the test fixture for relative measurements at the lower and upper extreme temperatures	82
B.4.4	Using the test fixture for normalized measurements	82
B.4.5	Using the test fixture for level independent measurements.....	83
B.5	Arrangement of the radiated test sites	83
B.5.1	Introduction	83
B.5.2	Power supplies for the battery powered UUT	83
B.5.3	Site preparation	83
B.6	Coupling of signals.....	84
B.6.1	General	84
B.6.2	Data signals	84
B.7	Interference signals used for channel access mechanism tests.....	84
B.7.1	Additive White Gaussian Noise (AWGN) test signal	84
B.7.2	OFDM test signal 1	84
B.7.3	OFDM test signal 2	85
B.7.4	Interference signal characteristics	85
B.7.4.1	Verification of flatness and bandwidth.....	85
B.7.4.2	Measurement of PSD.....	86
B.7.5	Waveforms for test signals	86
Annex C (normative):	Procedures for radiated measurements.....	87
C.1	Introduction	87
C.2	Radiated measurements in an OATS or SAR.....	87
C.3	Radiated measurements in a FAR	88
C.4	Substitution measurement	88
C.5	Testing technical requirements on equipment with an integral antenna	88
C.5.1	Radio test suites and corresponding test sites.....	88
C.5.2	Channel access mechanism testing.....	89
C.5.2.1	Introduction.....	89
C.5.2.2	Measurement set up	89
C.5.2.3	Calibration of the measurement set up.....	89
C.5.2.4	Test method	90
C.5.3	Receiver blocking testing	90
C.5.3.1	Introduction.....	90
C.5.3.2	Measurement set up	90
C.5.3.3	Calibration of the measurement set up.....	91
C.5.3.4	Test method	91
C.5.4	Receiver selectivity testing.....	92

C.5.4.1	Introduction.....	92
C.5.4.2	Measurement set up	92
C.5.4.3	Calibration of the measurement set up.....	92
C.5.4.4	Test method	93
Annex D (informative):	Maximum measurement uncertainty	94
Annex E (informative):	Examples of spectrum masks.....	95
E.1	Introduction	95
E.2	Equipment configured for multi-channel operation in groups of four adjacent channels	95
E.2.1	Example 1.....	95
E.2.2	Example 2.....	95
E.2.3	Example 3.....	96
E.2.4	Example 4.....	96
E.3	Equipment configured for multi-channel operation in 8 adjacent channels.....	97
E.3.1	Example 5.....	97
E.3.2	Example 6.....	98
E.3.3	Example 7.....	98
E.3.4	Example 8.....	99
E.3.5	Example 9.....	99
Annex F (informative):	Change history	100
History		101

Intellectual Property Rights

Essential patents

IPRs essential or potentially essential to normative deliverables may have been declared to ETSI. The declarations pertaining to these essential IPRs, if any, are publicly available for **ETSI members and non-members**, and can be found in ETSI SR 000 314: "*Intellectual Property Rights (IPRs); Essential, or potentially Essential, IPRs notified to ETSI in respect of ETSI standards*", which is available from the ETSI Secretariat. Latest updates are available on the ETSI Web server (<https://ipr.etsi.org/>).

Pursuant to the ETSI Directives including the ETSI IPR Policy, no investigation regarding the essentiality of IPRs, including IPR searches, has been carried out by ETSI. No guarantee can be given as to the existence of other IPRs not referenced in ETSI SR 000 314 (or the updates on the ETSI Web server) which are, or may be, or may become, essential to the present document.

Trademarks

The present document may include trademarks and/or tradenames which are asserted and/or registered by their owners. ETSI claims no ownership of these except for any which are indicated as being the property of ETSI, and conveys no right to use or reproduce any trademark and/or tradename. Mention of those trademarks in the present document does not constitute an endorsement by ETSI of products, services or organizations associated with those trademarks.

DECT™, **PLUGTESTS™**, **UMTS™** and the ETSI logo are trademarks of ETSI registered for the benefit of its Members. **3GPP™** and **LTE™** are trademarks of ETSI registered for the benefit of its Members and of the 3GPP Organizational Partners. **oneM2M™** logo is a trademark of ETSI registered for the benefit of its Members and of the oneM2M Partners. **GSM®** and the GSM logo are trademarks registered and owned by the GSM Association.

Foreword

This Harmonised European Standard (EN) has been produced by ETSI Technical Committee Broadband Radio Access Networks (BRAN).

The present document has been prepared under the Commission's standardisation request C(2015) 5376 final [i.2] to provide one voluntary means of conforming to the essential requirements of Directive 2014/53/EU on the harmonisation of the laws of the Member States relating to the making available on the market of radio equipment and repealing Directive 1999/5/EC [i.1].

Once the present document is cited in the Official Journal of the European Union under that Directive, compliance with the normative clauses of the present document given in table A.1 confers, within the limits of the scope of the present document, a presumption of conformity with the corresponding essential requirements of that Directive and associated EFTA regulations.

National transposition dates	
Date of adoption of this EN:	27 June 2023
Date of latest announcement of this EN (doa):	30 September 2023
Date of latest publication of new National Standard or endorsement of this EN (dop/e):	31 March 2024
Date of withdrawal of any conflicting National Standard (dow):	31 March 2025

Modal verbs terminology

In the present document "**shall**", "**shall not**", "**should**", "**should not**", "**may**", "**need not**", "**will**", "**will not**", "**can**" and "**cannot**" are to be interpreted as described in clause 3.2 of the [ETSI Drafting Rules](#) (Verbal forms for the expression of provisions).

"**must**" and "**must not**" are **NOT** allowed in ETSI deliverables except when used in direct citation.

Introduction

6 GHz Wireless Access Systems (WAS) including RLAN equipment are used in wireless local area networks which provide high speed data communications in between devices connected to the wireless infrastructure. The present document also addresses ad-hoc networking where devices communicate directly with each other, without the use of a wireless infrastructure.

The spectrum usage conditions for equipment within the scope of the present document are set in the ECC Decision (20)01 [i.3] and Commission Implementing Decision (EU) 2021/1067 of 17.6.2021 [i.11].

1 Scope

The present document specifies technical characteristics and methods of measurements for 6 GHz Wireless Access Systems including Radio Local Area Network (WAS/RLAN) equipment.

6 GHz WAS/RLAN equipment within the scope of the present document are covered by ECC and EU regulation as follows:

- ECC Decision (20)01 on the harmonised use of frequency band 5 945 MHz to 6 425 MHz for WAS/RLAN [i.3].
- Commission Implementing Decision (EU) 2021/1067 on the harmonised use of radio spectrum in the 5 945 MHz to 6 425 MHz frequency band for the implementation of wireless access systems including radio local area networks (WAS/RLANs) [i.11].

NOTE 1: Descriptions of 6 GHz WAS/RLAN equipment categories and sub-categories are provided in clause 4.2.

This radio equipment is capable of operating in all or parts of the frequency bands given in table 1.

Table 1: Service frequency band

	Service frequency band
Transmit	5 945 MHz to 6 425 MHz
Receive	5 945 MHz to 6 425 MHz

The present document describes spectrum access requirements to facilitate spectrum sharing with other equipment.

NOTE 2: The relationship between the present document and essential requirements of article 3.2 of Directive 2014/53/EU [i.1] is given in annex A.

2 References

2.1 Normative references

References are either specific (identified by date of publication and/or edition number or version number) or non-specific. For specific references, only the cited version applies. For non-specific references, the latest version of the referenced document (including any amendments) applies.

Referenced documents which are not found to be publicly available in the expected location might be found at <https://docbox.etsi.org/Reference/>.

NOTE: While any hyperlinks included in this clause were valid at the time of publication, ETSI cannot guarantee their long term validity.

The following referenced documents are necessary for the application of the present document.

- [1] [IEEE 802.11ax™-2021](#): "IEEE Standard for Information Technology - Telecommunications and Information Exchange between Systems - Local and Metropolitan Area Networks - Specific Requirements - Part 11: Wireless LAN Medium Access Control (MAC) and Physical Layer (PHY) Specifications - Amendment 1: Enhancements for High-Efficiency WLAN".
- [2] [ETSI TS 138 141-1 \(V17.8.0\) \(01-2023\)](#): "5G; NR; Base Station (BS) conformance testing Part 1: Conducted conformance testing (3GPP TS 38.141-1 version 17.8.0 Release 17)".
- [3] [ETSI TS 138 141-2 \(V17.8.0\) \(01-2023\)](#): "5G; NR; Base Station (BS) conformance testing Part 2: Radiated conformance testing (3GPP TS 38.141-2 version 17.8.0 Release 17)".

2.2 Informative references

References are either specific (identified by date of publication and/or edition number or version number) or non-specific. For specific references, only the cited version applies. For non-specific references, the latest version of the referenced document (including any amendments) applies.

NOTE: While any hyperlinks included in this clause were valid at the time of publication, ETSI cannot guarantee their long term validity.

The following referenced documents are not necessary for the application of the present document but they assist the user with regard to a particular subject area.

- [i.1] [Directive 2014/53/EU](#) of the European Parliament and of the Council of 16 April 2014 on the harmonisation of the laws of the Member States relating to the making available on the market of radio equipment and repealing Directive 1999/5/EC.
- [i.2] [Commission Implementing Decision C\(2015\) 5376 final of 4.8.2015](#) on a standardisation request to the European Committee for Electrotechnical Standardisation and to the European Telecommunications Standards Institute as regards radio equipment in support of Directive 2014/53/EU of the European Parliament and of the Council.
- [i.3] [ECC/DEC/\(20\)01 \(11-2020\)](#): "On the harmonised use of the frequency band 5945-6425 MHz for Wireless Access Systems including Radio Local Area Networks (WAS/RLAN)".
- [i.4] ETSI EG 203 367 (V1.1.1) (06-2016): "Guide to the application of harmonised standards covering articles 3.1b and 3.2 of the Directive 2014/53/EU (RED) to multi-radio and combined radio and non-radio equipment".
- [i.5] ETSI TR 100 028-1 (V1.4.1) (12-2001): "Electromagnetic compatibility and Radio spectrum Matters (ERM); Uncertainties in the measurement of mobile radio equipment characteristics; Part 1".
- [i.6] ETSI TR 100 028-2 (V1.4.1) (12-2001): "Electromagnetic compatibility and Radio spectrum Matters (ERM); Uncertainties in the measurement of mobile radio equipment characteristics; Part 2".
- [i.7] ETSI TR 102 273-2 (V1.2.1) (12-2001): "Electromagnetic compatibility and Radio spectrum Matters (ERM); Improvement on Radiated Methods of Measurement (using test site) and evaluation of the corresponding measurement uncertainties; Part 2: Anechoic chamber".
- [i.8] ETSI TR 102 273-3 (V1.2.1) (12-2001): "Electromagnetic compatibility and Radio spectrum Matters (ERM); Improvement on Radiated Methods of Measurement (using test site) and evaluation of the corresponding measurement uncertainties; Part 3: Anechoic chamber with a ground plane".
- [i.9] ETSI TR 102 273-4 (V1.2.1) (12-2001): "Electromagnetic compatibility and Radio spectrum Matters (ERM); Improvement on Radiated Methods of Measurement (using test site) and evaluation of the corresponding measurement uncertainties; Part 4: Open area test site".
- [i.10] [ERC Recommendation 74-01](#) (approved 1998, amended 29 May 2019, updated 1 October 2021 and corrected 23 May 2022): "Unwanted emissions in the spurious domain".
- [i.11] [Commission Implementing Decision \(EU\) 2021/1067 of 17.6.2021](#) on the harmonised use of radio spectrum in the 5 945-6 425 MHz frequency band for the implementation of wireless access systems including radio local area networks (WAS/RLANs).
- [i.12] ETSI EN 301 893: "5 GHz RLAN; Harmonised Standard covering the essential requirements of article 3.2 of Directive 2014/53/EU".

3 Definition of terms, symbols and abbreviations

3.1 Terms

For the purposes of the present document, the terms given in Directive 2014/53/EU [i.1] and the following apply:

6 GHz WAS/RLAN band: frequency range of 5 945 MHz to 6 425 MHz

adjacent signal: signal adjacent to the wanted signal

alternate adjacent channels: channel(s) offset from the wanted channel by twice the channel spacing

antenna assembly: combination of the antenna (integral or dedicated), its coaxial cable and if applicable, its antenna connector and associated switching components

NOTE 1: This term (antenna assembly) refers to an antenna connected to one transmit chain.

NOTE 2: The gain of an antenna assembly G in dBi, does not include the additional gain that may result out of beamforming.

backoff procedure: procedure that facilitates the sharing of the medium by randomizing the transmission attempts from multiple devices competing for access to a channel

beamforming gain: additional (antenna) gain realized by using beamforming techniques in smart antenna systems

NOTE: Beamforming gain as used in the present document does not include the gain of the antenna assembly.

burst: period during which radio waves are intentionally transmitted, preceded and succeeded by periods during which no data transmission is made

channel: continuous part of the radio-frequency spectrum used for transmission and reception by WAS/RLAN equipment and identified by a nominal centre frequency and a nominal bandwidth

NOTE: WAS/RLAN equipment is permitted to operate (transmit/receive) in one or more adjacent or non-adjacent channels simultaneously.

channel access engine: mechanism that determines when a transmission attempt is permitted

channel plan: list of channels with their centre frequencies and for each of the centre frequencies, the nominal bandwidth(s)

Clear Channel Assessment (CCA): mechanism used by an equipment to identify other transmissions in the channel

Contention Window (CW): main parameter that determines the duration of the backoff procedure

dedicated antenna: antenna external to the equipment, using an antenna connector with a cable or a wave-guide and which has been designed or developed for one or more specific types of equipment

Energy Detect (ED): mechanism used to determine the presence of transmissions in the channel based on detecting the signal energy of the transmission

environmental profile: range of environmental conditions under which equipment within the scope of the present document is required to comply with the provisions of the present document

Fixed Frame Period (FFP): periodic timing of the transmit/receive structure for Frame Based Equipment (FBE)

Frame Based Equipment (FBE): equipment where the transmit/receive structure has a periodic timing with a periodicity equal to the Fixed Frame Period (FFP)

frequency hopping: mechanism in which equipment switches between different hop frequencies within the 6 GHz WAS/RLAN band for its operations

hop frequency: centre frequency used for operations in the context of frequency hopping

initiating device: equipment that initiates a sequence of one or more transmissions

integral antenna: antenna designed as a fixed part of the equipment (without the use of an external connector) which cannot be disconnected from the equipment by a user with the intent to connect another antenna

NOTE 1: The term integral antenna is equivalent to integrated antenna.

NOTE 2: An integral antenna may be fitted internally or externally. In the case where the antenna is external, a non-detachable cable or wave-guide can be used.

Listen Before Talk (LBT): mechanism by which an equipment applies Clear Channel Assessment (CCA) before using the channel

Load Based Equipment (LBE): equipment where the transmit/receive structure is not fixed in time but demand-driven

Low Power Indoor Access Point (LPI AP): LPI access point or LPI bridge

NarrowBand (NB) device: VLP device that operates with a bandwidth below 20 MHz

observation slot: period during which the channel is checked for the presence of other transmissions

occupied channel: channel on which the channel access mechanism detected transmissions

post backoff : backoff procedure that is applied after every successful transmission

prioritization period: period consisting of an initial deferral period followed by an observation period during which the channel is checked for the presence of other transmissions

receive chain: receiver circuit with an associated antenna

responding device: equipment that transmits in response to the actions of an initiating device

smart antenna systems: equipment that combines multiple transmit and/or receive chains with a signal processing function to increase the throughput and/or to optimize its radiation and/or reception capabilities

stand-alone equipment: equipment that is intended primarily as radio communications equipment and that is normally used on a stand-alone basis

unoccupied channel: channel on which the channel access mechanism did not detect transmissions

WAS/RLAN: broadband radio systems that allow wireless access for public and private applications regardless of the underlying network topology

WAS/RLAN devices: components or sub-assemblies which intentionally emit and/or receive radio waves for the purpose of radio communication and are intended for incorporation into WAS/RLAN equipment

NOTE: Categories and sub-categories are provided in clause 4.2.

3.2 Symbols

For the purposes of the present document, the following symbols apply:

A	measured power output
CW_{\min}	minimum Contention Window size
CW_{\max}	maximum Contention Window size
D	measured Power Spectral Density
dB	decibel
dBc	dB relative to the transmit power
dB _i	dB relative to the gain of an isotropic antenna
dBm	dB relative to 1 mW
dB _r	dB relative to the reference level
E	field strength
E_0	reference field strength
f_c	nominal centre frequency for 20 MHz channels
f_{c_offset}	frequency offset from the nominal centre frequency
G	antenna Gain
GHz	Gigahertz

h	running index
Hz	Hertz
kHz	kiloHertz
M	frequency separation between the lower edge of the lowest channel in use and the higher edge of the highest channel in use in case of multi-channel operation where in a group of adjacent channels the lowest channel(s) and/or the highest channel(s) is/are not used for transmission
MHz	Megahertz
ms	millisecond
mW	milliwatt
N	Nominal bandwidth of a channel (or a group of channels in case of multi-channel operation)
n _{ch}	channel identifier
p	prioritization period related counter
P _{burst}	RMS (mean) power over the transmission burst
P _{max}	configured maximum transmit power (per channel, in dBm)
PD	calculated Power Spectral Density
q	backoff procedure related counter
Samples/s	Samples per second
T _{ch}	number of active transmit chains
Tx	Transmitter
TxOff	Transmitter off
TxOn	Transmitter on
U	total bandwidth of adjacent channels used for transmission in case of multi-channel operation where in a group of adjacent channels two or more channels not used for transmission are in between channels used for transmission
x	observed duty cycle
Y	beamforming (antenna) gain

3.3 Abbreviations

For the purposes of the present document, the following abbreviations apply:

ACK	Acknowledgement
AP	Access Point
ATT	ATTenuator
AWGN	Additive White Gaussian Noise
CCA	Clear Channel Assessment
COT	Channel Occupancy Time
CW	Contention Window
DC	Direct Current
ED	Energy Detect
EDT	Energy Detect Threshold
EFTA	European Free Trade Association
EIRP	Equivalent Isotropically Radiated Power
ERP	Effective Radiated Power
FAR	Fully Anechoic Room
FBE	Frame Based Equipment
FER	Frame Error Rate
FFP	Fixed Frame Period
IEEE	Institute of Electrical and Electronic Engineers
IF	Intermediate Frequency
LBE	Load Based Equipment
LBT	Listen Before Talk
LO	Local Oscillator
LPDA	Logarithmic Periodic Dipole Antenna
LPI	Low Power Indoor
NB	NarrowBand
NR	New Radio
OATS	Open Area Test Site
OFDM	Orthogonal Frequency Division Multiplexing
PER	Packet Error Rate
PFD	Power Flux Density

PHY	Physical layer
PSD	Power Spectral Density
RBW	Resolution Bandwidth
RF	Radio Frequency
RLAN	Radio Local Area Network
RMS	Root Mean Square
SAR	Semi Anechoic Room
SCS	Short Control Signalling
UAR	User Access Restrictions
UDP	User Datagram Protocol
UUT	Unit Under Test
VBW	Video BandWidth
VLP	Very Low Power
VSWR	Voltage Standing Wave Ratio
WAS	Wireless Access Systems

4 Technical requirements specifications

4.1 Environmental profile

The technical requirements of the present document apply under the environmental profile for operation of the equipment, which shall be in accordance with its intended use. The equipment shall comply with all the technical requirements of the present document at all times when operating within the boundary limits of the operational environmental profile defined by its intended use. Conformance tests shall be carried out under environmental conditions as defined in clause 5.1.

Where multiple combinations of radio equipment and antenna (antenna assemblies) are intended, each combination shall comply with all the technical requirements of the present document.

4.2 Equipment categories

4.2.1 Description of categories

The present document applies to WAS/RLAN equipment that operate under the LPI and VLP categories as defined in Commission Implementing Decision (EU) 2021/1067 final of 17.6.2021 [i.11].

The categories that apply to the equipment shall be noted in the test report, see clause 5.4.1, item a).

4.2.2 LPI category

There are two sub-categories of LPI devices as follows:

- LPI AP/bridge sub-category device
- LPI client sub-category device

4.2.3 VLP category

There is one category of VLP device.

NOTE: The VLP device may support NarrowBand (NB) usage as further defined in clause 4.3.3.2 and clause 4.3.3.3.

4.3 Conformance requirements

4.3.1 Nominal centre frequencies and nominal bandwidth

4.3.1.1 General

WAS/RLAN equipment typically operates on one or more fixed frequencies. The equipment is allowed to change its normal operating frequency when interference is detected, or to prevent causing interference to other equipment or for frequency planning purposes.

4.3.1.2 Definition

The nominal centre frequency is the centre of the channel.

The nominal bandwidth (N) is the widest band of frequencies, inclusive of guard bands, assigned to a channel.

4.3.1.3 Limits

The nominal centre frequencies for a nominal bandwidth of 20 MHz that falls completely within the 6 GHz WAS/RLAN band shall be defined by the formula below (see also figure 6):

$$f_c = 5\,935 + (n_{ch} \times 20) \text{ MHz} \pm f_{c_offset} \text{ where } n_{ch} \text{ is an integer and } 1 \leq n_{ch} \leq 24$$

An offset (f_{c_offset}) is permitted for each nominal centre frequency. The offset may be different for each nominal centre frequency, but it shall not be greater than 200 kHz. Where the manufacturer decides to make use of this frequency offset, the nominal centre frequencies used by the equipment shall be noted in the test report, see clause 5.4.1, item b).

The nominal centre frequency for any given channel shall be maintained within the range of $f_c \pm 0,002\%$.

The nominal bandwidth for a single channel shall be 20 MHz.

Equipment may have simultaneous transmissions on more than one channel with a nominal bandwidth of 20 MHz.

When equipment has simultaneous transmissions in adjacent channels, these transmissions may be considered as one signal with an actual nominal bandwidth (N) of "n" times the nominal bandwidth of an individual channel where "n" is the number of adjacent channels. When equipment has simultaneous transmissions in non-adjacent channels, each power envelope shall be considered separately.

The channel associated with an NB transmission is the 20 MHz channel that contains the centre frequency of the NB transmission, see clause 5.4.1 item b).

The nominal centre frequency formula in this clause is not applicable for the centre frequencies of VLP NB transmissions according to clause 4.3.3.3.

4.3.1.4 Conformance

Conformance tests as defined in clause 5.4.2 shall be carried out.

Conformance tests to the present clause are not applicable for VLP NB device operation that uses a frequency hopping mechanism, see clause 4.3.1.3.

4.3.2 RF output power

4.3.2.1 Definition

The RF output power is the mean Equivalent Isotropically Radiated Power (EIRP) during a transmission burst.

4.3.2.2 Limits

These limits are applicable to the system as a whole and in any possible configuration. The antenna gain of the integral or dedicated antenna has to be taken into account as well as the additional (beamforming) gain in case of smart antenna systems (devices with multiple transmit chains).

In case of multiple (adjacent or non-adjacent) channels, the total RF output power of all channels shall not exceed the limit given in table 2.

The RF output power shall not exceed the limits given in table 2.

Table 2: Mean EIRP limit for RF output power

Frequency range (MHz)	RF output power limit (dBm)	
	LPI usage	VLP usage
5 945 to 6 425	23	14

4.3.2.3 Conformance

Conformance tests as defined in clause 5.4.3 shall be carried out.

4.3.3 Power Spectral Density

4.3.3.1 Definition

The Power Spectral Density (PSD) is the mean Equivalent Isotropically Radiated Power (EIRP) density during a transmission burst.

4.3.3.2 Limits

These limits are applicable to the system as a whole and in any possible configuration. The antenna gain of the integral or dedicated antenna has to be taken into account as well as the additional (beamforming) gain in case of smart antenna systems (devices with multiple transmit chains).

The PSD shall not exceed the limits given in table 3.

Table 3: Mean EIRP density limit

Frequency range (MHz)	PSD limit (dBm/MHz)		
	LPI usage	VLP usage	VLP NB usage
5 945 to 6 425	10	1	10 (see clause 4.3.3.3)

4.3.3.3 VLP NB usage with a PSD above 1 dBm/MHz

The duty cycle of NarrowBand (NB) transmissions by a VLP device with a PSD above 1 dBm/MHz shall not exceed 1/15 on any transmission frequency.

NB devices require a frequency hopping mechanism based on at least 15 hop frequencies and meet the above duty cycle to operate at a PSD value above 1 dBm/MHz.

NOTE: Frequency hopping in the context of the present document implies the use of the channel access mechanisms and channelization as defined in the present document.

4.3.3.4 Conformance

Conformance tests as defined in clause 5.4.4 shall be carried out.

For VLP NB equipment making use of clause 4.3.3.3 conformance tests as defined in clause 5.4.12 shall also be performed.

4.3.4 Transmitter unwanted emissions

4.3.4.1 Transmitter unwanted emissions in the out-of-band domain

4.3.4.1.1 Definition

Transmitter unwanted emissions in the out-of-band domain are emissions outside of the 5 935 MHz to 6 425 MHz frequency range, but excluding unwanted emissions in the spurious domain, when the equipment is in transmit mode.

Where the nominal bandwidth (N) of the channel is less than 100 MHz then the boundary between the out-of-band and spurious domain is at a separation from the nominal centre frequency of the channel defined by $\pm 250\%$ of the nominal bandwidth.

Where the nominal bandwidth (N) of the channel is greater than or equal to 100 MHz then the boundary between the out-of-band and spurious domains is at a separation from the nominal centre frequency of the channel defined by $\pm 150\%$ of the nominal bandwidth +100 MHz. The boundaries of the out-of-band/spurious domains above and below the allocated band 5 935 MHz to 6 425 MHz shall be calculated based upon the nominal centre frequency of the highest and lowest channels supported by the equipment, respectively. These boundaries shall apply to all channels with a similar nominal bandwidth.

4.3.4.1.2 Limits

The level of Transmitter unwanted emissions in the out-of-band domain shall not exceed the limits given in table 4.

Table 4: Transmitter unwanted emission limits in the out-of-band domain

Equipment	Frequency (MHz)	Limit	Out-of-band/spurious domain boundary separation from the nominal centre frequency under test (where applicable)	
			N < 100 MHz	N ≥ 100 MHz
LPI	< 5 935	-22 dBm/MHz	$\pm 250\% \times N$	$\pm 150\% \times N + 100$ MHz
	> 6 425	Spectral power mask as defined by application of figure 1 and figure 2 (as applicable) in clause 4.3.4.3.2.		
VLP	< 5 935	-45 dBm/MHz (see note)		
	> 6 425	Spectral power mask as defined by application of figure 1 and figure 2 (as applicable) in clause 4.3.4.3.2.		

NOTE: See also Commission Implementing Decision (EU) 2021/1067 of 17.6.2021 [i.11], table 2, note 3.

4.3.4.1.3 Conformance

Conformance tests as defined in clause 5.4.5 shall be carried out.

4.3.4.2 Transmitter unwanted emissions in the spurious domain

4.3.4.2.1 Definition

Transmitter unwanted emissions in the spurious domain are emissions outside of the 6 GHz WAS/RLAN band and outside of the out-of-band domain when the equipment is in transmit mode.

4.3.4.2.2 Limits

The level of Transmitter unwanted emissions in the spurious domain shall not exceed the limits given in table 5.

In case of equipment with antenna connectors, these limits apply to emissions at the antenna port (conducted). For emissions radiated by the cabinet or emissions radiated by integral antenna equipment (without antenna connectors), these limits are ERP for emissions up to 1 GHz and EIRP for emissions above 1 GHz.

Table 5: Transmitter unwanted emission limits in the spurious domain

Frequency range	Maximum power	Measurement bandwidth
$30 \text{ MHz} \leq f < 87,5 \text{ MHz}$	-36 dBm	100 kHz
$87,5 \text{ MHz} \leq f \leq 118 \text{ MHz}$	-54 dBm	100 kHz
$118 \text{ MHz} < f < 174 \text{ MHz}$	-36 dBm	100 kHz
$174 \text{ MHz} \leq f \leq 230 \text{ MHz}$	-54 dBm	100 kHz
$230 \text{ MHz} < f < 470 \text{ MHz}$	-36 dBm	100 kHz
$470 \text{ MHz} \leq f \leq 694 \text{ MHz}$	-54 dBm	100 kHz
$694 \text{ MHz} < f \leq 1 \text{ GHz}$	-36 dBm	100 kHz
$1 \text{ GHz} < f \leq 26 \text{ GHz}$	-30 dBm	1 MHz

NOTE: Information in this table is based on ERC Recommendation 74-01 [i.10], annex 2, table 6.

4.3.4.2.3 Conformance

Conformance tests as defined in clause 5.4.5 shall be carried out.

4.3.4.3 Transmitter unwanted emissions within the 6 GHz WAS/RLAN band

4.3.4.3.1 Definition

Transmitter unwanted emissions within the 6 GHz WAS/RLAN band are radio frequency emissions within the frequency range defined in table 1.

4.3.4.3.2 Limits

4.3.4.3.2.1 General

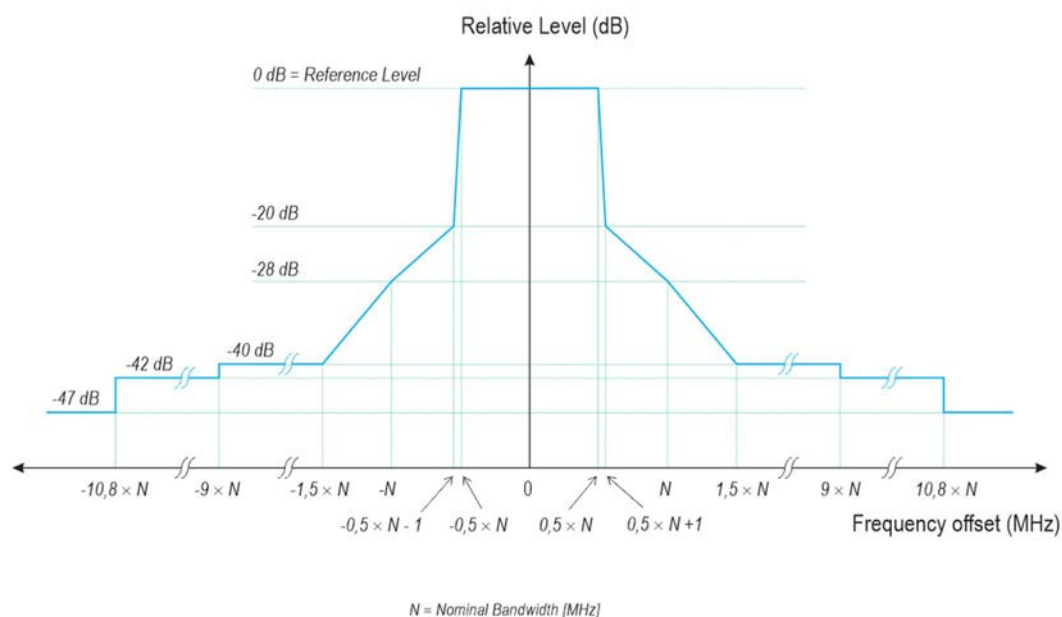
**Figure 1: Transmit spectral power mask**

The mean PSD (measured with a 1 MHz measurement bandwidth) of the transmitter unwanted emissions within and above the 6 GHz WAS/RLAN band shall not exceed the limits defined by application of the masks provided in clause 4.3.4.3.2 or an absolute level defined by the applicable out-of-band or spurious domain limits based on ERC Recommendation 74-01 [i.10], whichever is greater.

In case of smart antenna systems (devices with multiple transmit chains) each of the transmit chains shall meet the limits defined by application of the masks provided in clause 4.3.4.3.2.

In case of multi-channel operation in adjacent or non-adjacent channels, clause 4.3.4.3.2.2 and clause 4.3.4.3.2.3 describe how the overall transmit spectral power mask to be applied shall be constructed.

It shall be noted in the test report which channel edge masks for multi-channel operation in adjacent and/or non-adjacent channels are supported by the equipment, see clause 5.4.1, item c).

The channel associated with an NB transmission is defined in clause 4.3.1.3. An NB transmission shall conform to the transmit spectral power mask of this channel (i.e. with $N = 20$ MHz and nominal centre frequencies based upon the formula in clause 4.3.1.3).

4.3.4.3.2.2 Multi-channel operation in adjacent channels

For equipment configured for multi-channel operation (see clause 4.3.6.3.1.3 or clause 4.3.6.3.2.3) using a group of adjacent channels and transmissions take place in all these adjacent channels, these transmissions may be considered as one signal with an actual nominal bandwidth (N) of "n" times the nominal bandwidth of an individual channel where "n" is the number of adjacent channels used simultaneously. This signal shall be subject to the limits provided by the mask in figure 1.

In case of a multi-channel configuration using a group of adjacent channels and transmissions do not take place in all the adjacent channels, the overall transmit spectral power mask is constructed from the mask provided in figure 1 together with additional restrictions as described below for the channels not used for transmission in the group of adjacent channels:

- When the lowest channel(s) and/or the highest channel(s) of a group of adjacent channels is/are not used for transmission, an additional channel edge mask as in figure 2 shall be applied at the lower edge of the lowest channel used for transmission and at the higher edge of the highest channel used for transmission. M is the separation in MHz between these two edges.

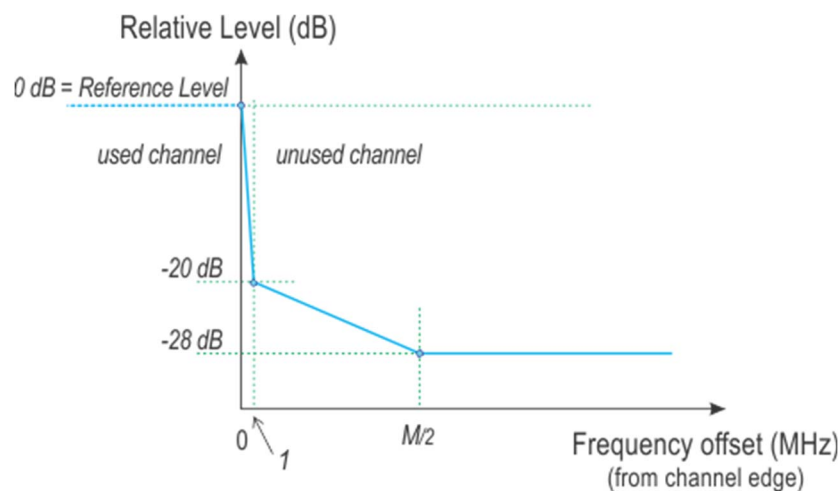

Figure 2: Channel edge mask - case 1

- When there are two or more channels not used for transmission in between channels used for transmission (all belonging to the same group of adjacent channels configured for multi-channel operation) and these channels not used for transmission are adjacent to each other, an additional channel edge mask as in figure 3 shall be applied at the higher edge of the channel adjacent to the lowest channel of the group of adjacent channels not used for transmission and at the lower edge of the channel adjacent to the highest channel of the group of adjacent channels not used for transmission. U is the total bandwidth of channels in use adjacent to the channels not used for transmission.

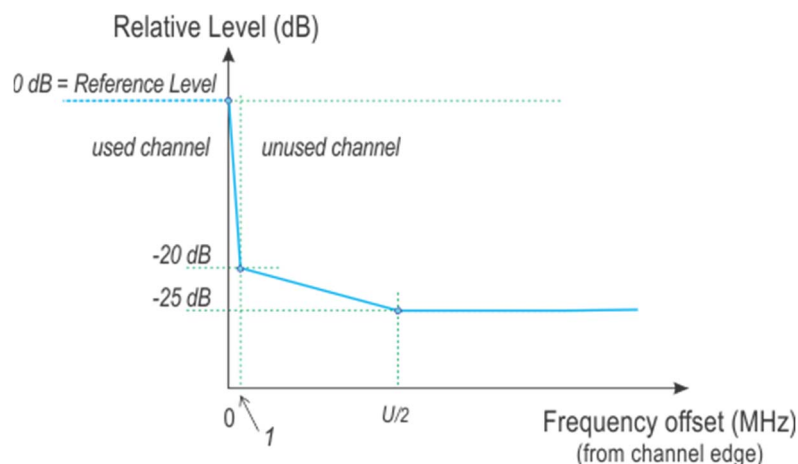

Figure 3: Channel edge mask - case 2

- When there is only one channel not used for transmission in between channels in use (all belonging to the group of adjacent channels configured for multi-channel operation), an additional mask as in figure 4 shall be applied at the higher edge of the channel below the channel not used for transmission and at the lower edge of the channel above the channel not used for transmission.

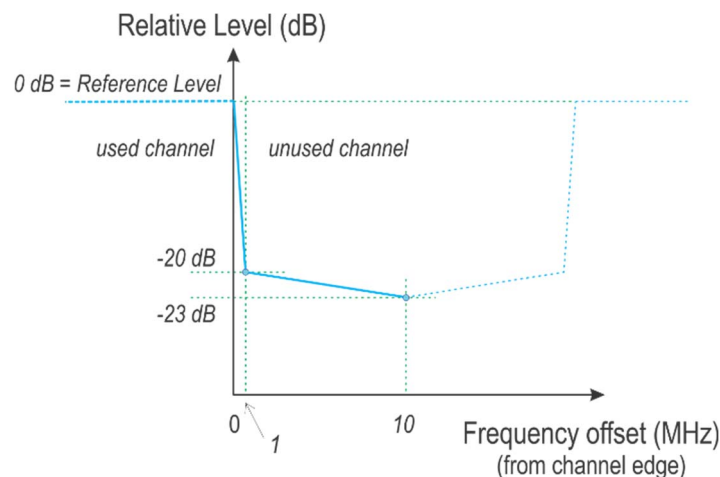

Figure 4: Channel edge mask - case 3

The Local Oscillator (LO) power in a 2 MHz band may exceed the limits provided by the overall transmit spectral power mask (constructed from the masks above) but shall be less than -28 dBc relative to the total transmit power within the group of adjacent channels, or less than -20 dBm/MHz, whichever is greater. A 2 MHz band per LO can be located anywhere within the nominal bandwidth of the group of adjacent channels configured for multi-channel operation. The LO exceedance shall not occur more than once per 20 MHz of the nominal bandwidth for a group of adjacent channels. For the specific case of a 40 MHz nominal bandwidth (N) configured for multi-channel operation and only one channel is being used, the LO exceedance shall not be more than 0 dB_r if occurring.

Annex E contains a number of examples of how the overall transmit spectral power mask is constructed.

4.3.4.3.2.3 Multi-channel operation in non-adjacent channels

For simultaneous transmissions in multiple non-adjacent channels (or non-adjacent groups of adjacent channels), the overall transmit spectral power mask is constructed in the following manner. First, the procedure as described in clause 4.3.4.3.2.2 shall be applied to each of the channels (or to each group of adjacent channels). Then, for each frequency point, the greatest value from the applicable transmit spectral power masks for each of the channels (or group of adjacent channels) assessed shall be taken as the overall spectral power mask requirement at that frequency.

4.3.4.3.3 Conformance

Conformance tests as defined in clause 5.4.6 shall be carried out.

4.3.5 Receiver spurious emissions

4.3.5.1 Definition

Receiver spurious emissions are emissions at any frequency when the equipment is in receive mode.

4.3.5.2 Limits

The receiver spurious emissions shall not exceed the limits given in table 6.

Table 6: Spurious radiated emission limits

Frequency range	Maximum power	Measurement bandwidth
$30 \text{ MHz} \leq f \leq 1 \text{ GHz}$	-57 dBm	100 kHz
$1 \text{ GHz} < f \leq 26 \text{ GHz}$	-47 dBm	1 MHz

NOTE: Information in this table is based on ERC Recommendation 74-01 [i.10], annex 2, table 6.

4.3.5.3 Conformance

Conformance tests as defined in clause 5.4.7 shall be carried out.

4.3.6 Channel access mechanism

4.3.6.1 Applicability

The present requirement applies to all equipment within the scope of the present document.

The present document defines two alternative types of channel access mechanisms for equipment to operate either as:

- Frame Based Equipment (FBE), see clause 4.3.6.3.1; or
- Load Based Equipment (LBE), see clause 4.3.6.3.2.

Energy Detection Threshold (EDT) level and Short Control Signalling (SCS) transmissions requirements that apply to both FBE and LBE channel access mechanisms are included in clause 4.3.6.3.3 and clause 4.3.6.3.4 respectively.

4.3.6.2 Definition

A channel access mechanism is an automatic mechanism by which equipment gains access to a channel.

4.3.6.3 Requirements and limits

4.3.6.3.1 Channel access mechanism for Frame Based Equipment (FBE)

4.3.6.3.1.1 Introduction

FBE implements a Listen Before Talk (LBT) based channel access mechanism to detect the presence of other WAS/RLAN transmissions on a channel.

FBE is equipment where the transmit/receive structure has a periodic timing with a periodicity equal to the Fixed Frame Period (FFP). A single observation slot as defined in clause 3.1 and as referenced by the procedure in clause 4.3.6.3.1.4 shall have a duration of not less than 9 μs .

4.3.6.3.1.2 Equipment types

Equipment that initiates a sequence of one or more transmissions is denoted as the initiating device. Otherwise, the equipment is denoted as a responding device. FBE may be an initiating device, a responding device or both.

The initiating device shall implement a channel access mechanism as further described in clause 4.3.6.3.1.4.

A responding device shall implement a channel access mechanism as further described in clause 4.3.6.3.1.5.

4.3.6.3.1.3 Multi-channel operation

FBE being capable of simultaneous transmissions in adjacent or non-adjacent channels (see clause 4.3.1) may use any combination/grouping of 20 MHz channels out of the list of channels (nominal centre frequencies) provided in clause 4.3.1, if it satisfies the channel access requirements (channel access mechanism) for an initiating device as described in clause 4.3.6.3.1.4 on each such 20 MHz channel.

4.3.6.3.1.4 Initiating device channel access mechanism (FBE)

The initiating device (FBE) shall implement a channel access mechanism that conforms to the following requirements:

- 1) The FFPs supported by the equipment shall be noted in the test report, see clause 5.4.1, item j). This shall be within the range of 1 ms to 10 ms. Transmissions can start only within the minimum idle period starting from the beginning of a FFP. See figure 5 below. An equipment may change its FFP but it shall not do so more than once every 200 ms.
- 2) Immediately before starting transmissions on a channel or group of adjacent or non-adjacent channels the initiating device shall perform a Clear Channel Assessment (CCA) check during a single observation slot. A channel is an occupied channel as long as transmissions in that channel are present at a power level greater than the ED Threshold (EDT) in clause 4.3.6.3.3. The power level is determined by integrating the received power over the channel, and then normalizing to per MHz power. The received power shall be measured at the interface between the equipment and the antenna assembly. If no transmissions are present at a power level greater than the EDT, the channel is an unoccupied channel. Transmissions may start on an unoccupied channel. See figure 5.

If the channel is an occupied channel, the initiating device shall not transmit on the channel during the FFP (see figure 5). The FBE is allowed to continue Short Control Signalling (SCS) transmissions on the channel providing it conforms to the requirements given in clause 4.3.6.3.4.

For equipment having simultaneous transmissions on multiple (adjacent or non-adjacent) channels, the equipment is allowed to continue transmissions on other channels that are unoccupied channels.

The total time during which FBE can have transmissions on a given channel, for a given FFP is defined as the Channel Occupancy Time (COT).

The equipment can have multiple transmissions within a COT without performing an additional CCA on this channel providing the gap between such transmissions does not exceed 18 μ s.

If the gap exceeds 18 μ s, the equipment may continue transmissions provided that an additional CCA detects no WAS/RLAN transmissions with a level above the EDT defined in clause 4.3.6.3.3. The additional CCA shall be performed within the gap and within the observation slot immediately before transmission. All gaps are counted as part of the COT.

- 3) An initiating device is allowed to grant an authorization to one or more associated responding devices to transmit on the current channel within the current COT. A responding device that receives such a grant shall follow the procedure described in clause 4.3.6.3.1.5.
- 4) The COT shall not be greater than 95 % of the FFP defined in point 1) and shall be followed by the remaining idle period until the start of the next FFP such that the total idle period is at least equal to the minimum idle period, i.e. 5 % of the COT, with a minimum of 100 μ s.
- 5) The equipment, upon correct reception of a packet which was intended for this equipment, can skip CCA and immediately proceed with the transmission of management and control frames (e.g. ACK and Block ACK frames). A consecutive sequence of such transmissions by the equipment, without it performing a new CCA, shall not exceed the maximum COT as defined in point 4) above.

For the purpose of multi-cast, the ACK transmissions (associated with the same data packet) of the individual devices are allowed to take place in a sequence.

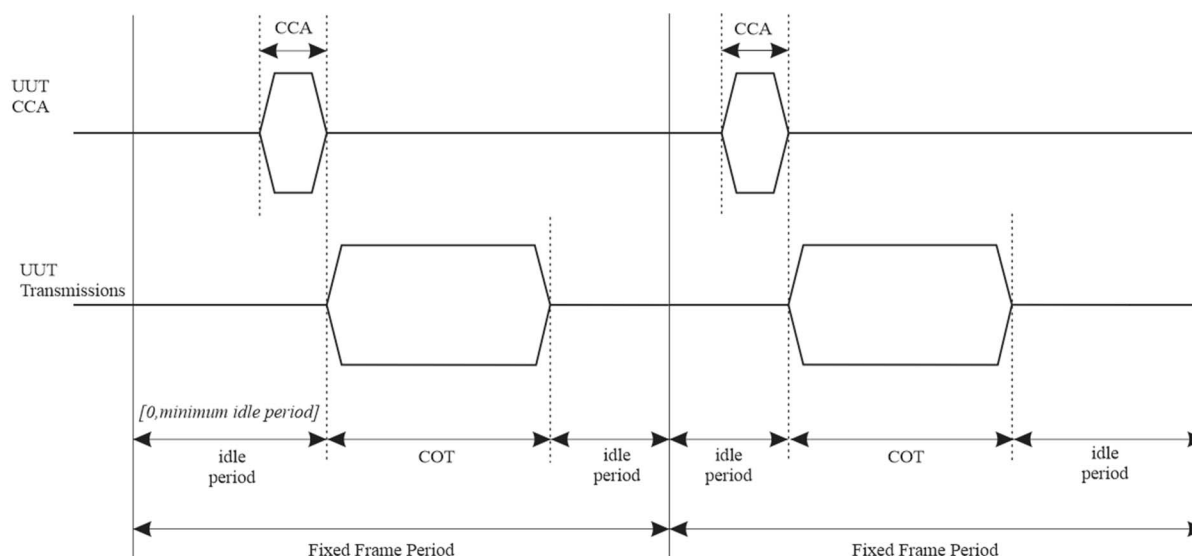

Figure 5: Example of timing for FBE

4.3.6.3.1.5 Responding device channel access mechanism (FBE)

Clause 4.3.6.3.1.4, point 3) describes the possibility whereby an initiating device grants an authorization to one or more associated responding devices to transmit on the current channel within the current FFP. A responding device that receives such a grant shall follow the procedure described in step 1) to step 3):

- 1) A responding device that received a transmission grant from an associated initiating device may proceed with transmissions on the current channel:
 - a) The responding device may proceed with such transmissions without performing a CCA if these transmissions are initiated at most 18 μs after the last transmission by the initiating device that issued the grant.
 - b) The responding device that does not proceed with such transmissions within 18 μs after the last transmission from the initiating device that issued the grant, shall perform a CCA on the channel during a single observation slot within a 27 μs period ending immediately before the granted transmission time. If energy was detected with a level above the EDT defined in clause 4.3.6.3.3), the responding device shall proceed with step 3). Otherwise, the responding device shall proceed with step 2).
- 2) The responding device may perform transmissions on the current channel for the remaining COT of the current FFP. The responding device may have multiple transmissions on this channel provided that the gap in between such transmissions does not exceed 18 μs . When the transmissions by the responding device are completed the responding device shall proceed with step 3).
- 3) The transmission grant for the responding device is withdrawn.

4.3.6.3.2 Channel access mechanism for Load Based Equipment (LBE)

4.3.6.3.2.1 Introduction

Load Based Equipment implements a Listen Before Talk (LBT) based channel access mechanism to detect the presence of other WAS/RLAN transmissions on a channel.

4.3.6.3.2.2 Equipment types

With regard to the channel access mechanism for LBE, equipment that initiates a sequence of one or more transmissions is denoted as the initiating device. Otherwise, the equipment is denoted as a responding device. LBE may be an initiating device, a responding device or both.

The initiating device shall implement a channel access mechanism with prioritized, truncated exponential backoff procedure as further described in clause 4.3.6.3.2.5.

A responding device shall implement a channel access mechanism as further described in clause 4.3.6.3.2.6.

Each transmission belongs to a single COT. A COT consists of one or more transmissions of an initiating device and zero or more transmissions of one or more responding devices.

An equipment that controls operating parameters of one or more other equipment is denoted as a supervising device. Otherwise, the equipment is denoted as a supervised device.

EXAMPLE: Examples of supervising devices are an RLAN Access Point or a mobile phone operating as an RLAN hotspot.

4.3.6.3.2.3 Multi-channel operation

LBE being capable of simultaneous transmissions in adjacent or non-adjacent channel (see clause 4.3.1) shall implement either option 1 or option 2 below:

Option 1: LBE may use any combination/grouping of channels out of the list of channels (nominal centre frequencies) provided in clause 4.3.1, if it satisfies the channel access requirements (channel access mechanism) for an initiating device as described in clause 4.3.6.3.2.5 on each such channel.

Option 2: Figure 6 defines groups of adjacent channels with a total bandwidth of 40 MHz, 80 MHz or 160 MHz (see also clause 4.3.1.3 for the channel number). LBE that uses a combination/grouping of adjacent channels that is a subset of the 40 MHz, 80 MHz or 160 MHz groups of adjacent channels in figure 6 may transmit on any of the channels, if:

- the equipment satisfies the channel access requirements (channel access mechanism) for an initiating device as defined in clause 4.3.6.3.2.5 on one of the channels (primary channel); and
- the equipment performs a CCA of at least 23 μ s immediately before the intended transmissions on each of the other channels on which transmissions are intended, and no energy was detected with a level above the ED Threshold (EDT) levels defined in clause 4.3.6.3.3.

The choice of the primary channel shall follow one of the following procedures:

- The primary channel is chosen uniformly randomly whenever the Contention Window (CW), corresponding to a completed transmission on the current primary channel is set to its minimum value (CW_{min}). For this procedure, a CW is maintained for each priority class (see clause 4.3.6.3.2.4) within each channel from the group of adjacent channels.
- The primary channel is arbitrarily determined and not changed more than once per second.

The group of adjacent channels of 40 MHz, 80 MHz or 160 MHz that the combination/grouping of channels is a subset of shall not be changed more than once per second.

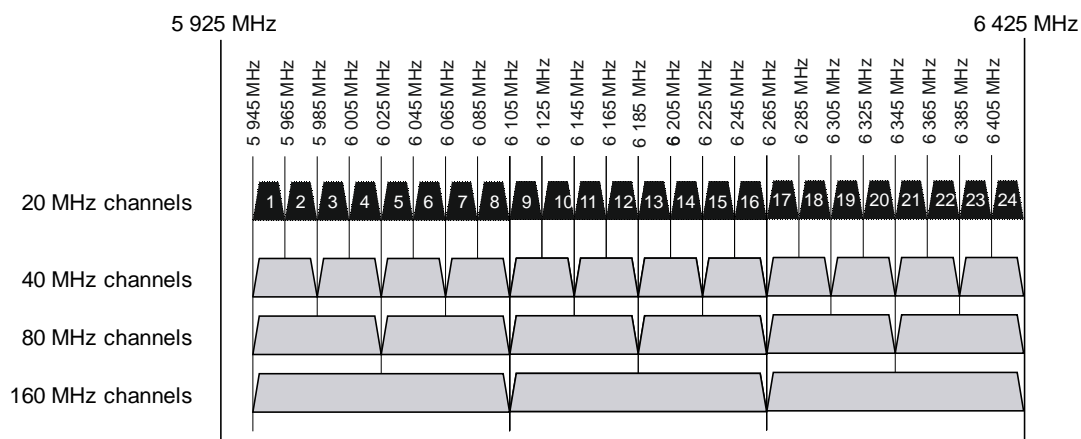

Figure 6: Groups of adjacent channels for option 2

4.3.6.3.2.4 Priority classes

Table 7 and table 8 each contain four different sets of channel access parameters for supervising devices and supervised devices respectively, resulting in different priority classes and different maximum COTs. These parameters are used by the channel access mechanism for the initiating device described in clause 4.3.6.3.2.5 to gain access to a channel.

If a channel occupancy consists of more than one transmission the transmissions may be separated by gaps. The COT is the total duration that an initiating device and any responding devices occupy one or more channels and includes all gaps of 27 μ s duration or less. The total duration of a channel occupancy shall not exceed the maximum COT in table 7 and table 8. If a channel occupancy has gaps exceeding 27 μ s, the duration from the start of the first transmission of a channel occupancy until the end of the last transmission of the same channel occupancy shall not exceed 20 ms.

The initiating device may have data to be transmitted in different priority classes and therefore the channel access mechanism is allowed to operate different channel access engines as described in clause 4.3.6.3.2.5 simultaneously (one for each implemented priority class).

Table 7: Priority class dependent channel access parameters for supervising devices

Class #	p_0	CW_{min}	CW_{max}	Maximum Channel Occupancy Time (COT)
4	1	3	7	2 ms
3	1	7	15	4 ms
2	3	15	63	6 ms (see note 1 and note 2)
1	7	15	1 023	6 ms (see note 1)

NOTE 1: The maximum COT of 6 ms may be increased to 8 ms by inserting one or more pauses. The minimum duration of a pause shall be 100 μ s. The maximum duration (channel occupancy) before including any such pause shall be 6 ms. Pause duration is not included in the COT.

NOTE 2: The maximum COT of 6 ms may be increased to 10 ms by extending CW to $CW \times 2 + 1$ when selecting the random number q for any backoff(s) that precede the channel occupancy that may exceed 6 ms or which follow the channel occupancy that exceeded 6 ms. The choice between preceding or following a channel occupancy shall remain unchanged during the operation time of the device.

NOTE 3: The values for p_0 , CW_{min} , CW_{max} are minimum values. Greater values are allowed.

Table 8: Priority class dependent channel access parameters for supervised devices

Class #	p_0	CW_{min}	CW_{max}	Maximum Channel Occupancy Time (COT)
4	2	3	7	2 ms
3	2	7	15	4 ms
2	3	15	1 023	6 ms (see note 1)
1	7	15	1 023	6 ms (see note 1)
NOTE 1: The maximum COT of 6 ms may be increased to 8 ms by inserting one or more pauses. The minimum duration of a pause shall be 100 μ s. The maximum duration (channel occupancy) before including any such pause shall be 6 ms. Pause duration is not included in the COT.				
NOTE 2: The values for p_0 , CW_{min} , CW_{max} are minimum values. Greater values are allowed.				

4.3.6.3.2.5 Initiating device channel access mechanism (LBE)

Before a transmission or a burst of transmissions on a channel or group of adjacent or non-adjacent channels, the initiating device shall operate at least one channel access engine that executes the procedure described in step 1) to step 7) below. This channel access engine makes use of the parameters defined in table 7 or table 8 in clause 4.3.6.3.2.4.

A single observation slot as defined in clause 3.1 and as referenced by the procedure in the present clause shall have a duration of not less than 9 μ s.

An initiating device shall operate at least one and no more than four different channel access engines each with a different priority class as defined in clause 4.3.6.3.2.4:

- 1) The channel access engine shall set CW to CW_{min} .
- 2) The channel access engine shall select a random number q from a uniform distribution over the range 0 to CW . Note 2 in table 7 defines an alternative range for q when the previous or next COT is greater than the maximum COT specified in table 7.
- 3) The channel access engine shall initiate a prioritization period as described in step 3) a) to step 3) c):
 - a) The channel access engine shall set p equal to p_0 according to the priority class associated with this channel access engine. See clause 4.3.6.3.2.4.
 - b) The channel access engine shall wait for a period of at least 14 μ s.
 - c) The channel access engine shall perform a CCA on the channel. During a single observation slot the channel access engine shall determine if the channel or combination of channels are occupied channel(s):
 - i) For the channel(s) that have been detected as occupied, the channel access engine shall initiate a new prioritization period starting with step 3) a) after the energy within the channel(s) has dropped below the EDT defined in clause 4.3.6.3.3.
 - ii) For the channels that have been determined as unoccupied channels, p may be decremented by not more than 1. If p is equal to 0, the channel access engine shall proceed with step 4), otherwise the channel access engine shall proceed with step 3) c).
- 4) The channel access engine shall perform a backoff procedure as described in step 4) a) to step 4) d):
 - a) This step verifies if the channel access engine satisfies the post backoff condition. If $q < 0$ and the channel access engine is ready for a transmission, the channel access engine shall set CW equal to CW_{min} and shall select a random number q from a uniform distribution over the range 0 to CW before proceeding with step 4) b). Note 2 in table 7 defines an alternative range for q when the previous or next COT is greater than the maximum COT specified in table 7.
 - b) If $q < 1$ the channel access engine shall proceed with step 4) d). Otherwise, the channel access engine may decrement the value q by not more than 1 and the channel access engine shall proceed with step 4) c).

- c) The channel access engine shall perform a CCA on the channel. During a single observation slot the channel access engine shall determine if the channel or combination of channels are occupied channel(s) or unoccupied channel(s):
- i) For the channel(s) that have been determined as occupied channel(s), the channel access engine shall continue with step 3).
 - ii) For the channel(s) that have been detected as unoccupied channel(s) the channel access engine shall continue with step 4) b).
- d) If the channel access engine is ready for a transmission the channel access engine shall continue with step 5). Otherwise, the channel access engine shall decrement the value q by 1 and the channel access engine shall proceed with step 4) c). It should be understood that q can become negative and keep decrementing as long as the channel access engine is not ready for a transmission.
- 5) If only one channel access engine of the initiating device is in this stage (see note 1) the channel access engine shall proceed with step 6). If the initiating device has a multitude of channel access engines in this stage (see note 2), channel access engine with highest priority class in this multitude shall proceed with step 6) and all other channel access engines in the current stage shall proceed with step 7).

NOTE 1: This is equivalent to the equipment having no internal collision.

NOTE 2: This is equivalent to the equipment having one or more internal collisions.

- 6) The channel access engine may start transmissions belonging to the corresponding or higher priority classes, on one or more channels. If the initiating device transmits in more than one channel, it shall conform to the requirements defined for multi-channel operation:
- a) The initiating device and its responding devices can have multiple transmissions without performing an additional CCA on the channel or combination of channels providing the gap in between such transmissions does not exceed $18 \mu\text{s}$. Otherwise, if this gap exceeds $18 \mu\text{s}$ and does not exceed $27 \mu\text{s}$ the initiating device may continue transmissions provided that for a duration of one observation slot the initiating device found the channel(s) to be unoccupied channel(s).
 - b) The channel access engine may grant up to ten authorizations to transmit on the current channel to each of one or more responding devices. If the initiating device issues such a transmission grant to a responding device, the responding device shall operate according to the procedure described in clause 4.3.6.3.2.6.
 - c) The initiating device may have simultaneous transmissions of priority classes lower than the priority class of the channel access engine, provided that the corresponding transmission duration (COT) is not extended beyond the time that is needed for the transmission(s) corresponding to the priority class of the channel access engine.
- 7) When the channel occupancy has completed, CW shall be updated as specified below, and the initiating device proceeds with step 2).

According to clause 4.3.6.3.2.4 where four different priority classes are defined, an initiating device shall operate only one channel access engine for each priority class implemented.

CW may take values that are greater than the values of CW in step 1) to step 7).

Updating CW is based on feedback about the success or failure of channel occupancies.

Success and failure of a channel occupancy are defined as follows:

- a channel occupancy is a success when at least one transmission that started at the beginning of the channel occupancy was successful or when there is no intention to retransmit any part of the information transmitted during the channel occupancy;
- otherwise, the channel occupancy is a failure.

When CW is updated:

- if new feedback is available relative to the prior CW update, the feedback for the latest COT for which new feedback is received shall be used:
 - if the feedback indicates success, CW shall be set to CW_{\min} ;
 - if the feedback indicates failure, CW shall be set to $\min(CW \times 2 + 1, CW_{\max})$;
- otherwise, CW shall remain the same.

During normal operation, there is no bias towards success in the selection of the feedback used to update CW.

4.3.6.3.2.6 Responding device channel access mechanism (LBE)

Clause 4.3.6.3.2.5, step 6) b) describes the possibility whereby an initiating device grants an authorization to one or more associated responding devices to transmit on the current channel. A responding device that receives such a grant shall follow the procedure described in step 1) to step 3):

- 1) A responding device that received a transmission grant from an associated initiating device may proceed with transmissions on the current channel. The responding device shall set h equal to the number of transmission times that the initiating device granted to the responding device:
 - a) The responding device may proceed with such transmissions without performing a CCA if these transmissions are initiated at most $18 \mu\text{s}$ after the last transmission by the initiating device that issued the grant.
 - b) The responding device that does not proceed with such transmissions within $18 \mu\text{s}$ after the last transmission within the channel occupancy, shall perform a CCA on the channel during a single observation slot within a $27 \mu\text{s}$ period ending immediately before the h -th granted transmission time. The channel access engine shall determine whether the channel is an occupied channel or an unoccupied channel. If the channel is an occupied channel, the responding device shall proceed with step 1) c). If the channel is an unoccupied channel, the responding device shall proceed with step 2).
 - c) The responding device shall decrement h by 1. If $h \leq 0$, the responding device shall proceed with step 3). Otherwise, the responding device shall proceed with step 1) b).
- 2) The responding device may perform transmissions on the current channel for the remaining COT. The responding device may have multiple transmissions on this channel provided that the gap in between such transmissions does not exceed $18 \mu\text{s}$. When the transmissions by the responding device are completed the responding device shall proceed with step 3).
- 3) The transmission grant for the responding device is withdrawn.

4.3.6.3.3 ED Threshold level (Energy Detection Threshold level, FBE and LBE)

A channel is an occupied channel as long as transmissions in that channel are present at a power level greater than the ED Threshold (EDT). The power level is determined by integrating the received power over the channel, and then normalized to per MHz power. The received power shall be measured at the interface between the equipment and the antenna assembly. If no transmissions are present at a power level greater than the EDT, the channel is an unoccupied channel.

The EDT is proportional to the equipment's maximum configured transmit power (P_{\max}):

- | | |
|---|---|
| For $P_{\max} \leq 14 \text{ dBm}$: | $EDT = -75 \text{ dBm/MHz}$ |
| For $14 \text{ dBm} < P_{\max} \leq 24 \text{ dBm}$: | $EDT = -85 \text{ dBm/MHz} + (24 \text{ dBm} - P_{\max})$ |
| For $P_{\max} \geq 24 \text{ dBm}$: | $EDT = -85 \text{ dBm/MHz}$ |

The EDT levels defined above are absolute levels that apply at all times.

The channel associated with an NB transmission is defined in clause 4.3.1.3.

4.3.6.3.4 Short Control Signalling transmissions (FBE and LBE)

4.3.6.3.4.1 General

FBE and LBE are allowed to have Short Control Signalling (SCS) transmissions on the channel providing these transmissions conform to the limits defined in clause 4.3.6.3.4.3.

4.3.6.3.4.2 Definition

SCS transmissions are transmissions used by the equipment to send management and control frames without sensing the channel for the presence of other signals.

4.3.6.3.4.3 Limits

The use of SCS transmissions is constrained as follows:

- within an observation period of 50 ms, the number of SCS transmissions by the equipment shall be equal to or less than 50; and
- the total duration of the equipment's SCS transmissions shall be less than 2 500 μ s within said observation period.

4.3.6.4 Conformance

The conformance tests for this requirement are defined in clause 5.4.8.

4.3.7 Receiver blocking

4.3.7.1 Definition

Receiver blocking is a measure of the capability of the equipment to receive a wanted signal on its channel without exceeding a given degradation due to the presence of an unwanted input signal (blocking signal) on frequencies other than those of the operating band provided in table 1.

4.3.7.2 Performance criteria

For equipment that supports a PER or FER test to be performed, the minimum performance criterion shall be a PER or FER less than or equal to 10 %.

For equipment that does not support a PER or a FER test to be performed, the minimum performance criterion shall be no loss of the wireless transmission function needed for the intended use of the equipment.

4.3.7.3 Limits

While maintaining the minimum performance criteria as defined in clause 4.3.7.2, the blocking levels at specified frequency offsets shall be equal to or greater than the limits given in table 9 or table 10.

Table 9: LPI Receiver blocking parameters

Wanted signal mean power from companion device (dBm)	Blocking signal frequency (MHz)	Blocking signal power (dBm) (see note 2)	Type of blocking signal
$P_{\min} + 6$ dB	5 895 (see note 3) 6 475	-53	Continuous Wave
$P_{\min} + 6$ dB	5 695 (see note 3) 5 795 (see note 3) 6 575 6 675	-47	Continuous Wave
<p>NOTE 1: P_{\min} is the minimum level of the wanted signal (in dBm) required to meet the minimum performance criteria as defined clause 4.3.7.2 in the absence of any blocking signal.</p> <p>NOTE 2: The levels are specified at the UUT antenna connector(s). In case of radiated measurements on a UUT with an integral antenna equipment without external (temporary) antenna connector(s) provided, the equivalent Power Flux Density (PFD) at the UUT is the ratio of the level specified and the antenna area of the UUT antenna. In case of radiated measurements with a substitution antenna, the equivalent PFD at the said antenna is the ratio of the level specified and the antenna area of the substitution antenna.</p> <p>NOTE 3: Where the equipment also supports WAS/RLAN operation in the 5 GHz bands compliant with ETSI EN 301 893 [i.12], this frequency is not to be tested.</p>			

Table 10: VLP Receiver blocking parameters

Wanted signal mean power from companion device (dBm)	Blocking signal frequency (MHz)	Blocking signal power (dBm) (see note 2)	Type of blocking signal
$P_{\min} + 6$ dB	5 895 (see note 3) 6 475	-58	Continuous Wave
$P_{\min} + 6$ dB	5 695 (see note 3) 5 795 (see note 3) 6 575 6 675		Continuous Wave
<p>NOTE 1: P_{\min} is the minimum level of the wanted signal (in dBm) required to meet the minimum performance criteria as defined clause 4.3.7.2 in the absence of any blocking signal.</p> <p>NOTE 2: The levels are specified at the UUT antenna connector(s). In case of radiated measurements on a UUT with an integral antenna equipment without external (temporary) antenna connector(s) provided, the equivalent Power Flux Density (PFD) at the UUT is the ratio of the level specified and the antenna area of the UUT antenna. In case of radiated measurements with a substitution antenna, the equivalent PFD at the said antenna is the ratio of the level specified and the antenna area of the substitution antenna.</p> <p>NOTE 3: Where the equipment also supports WAS/RLAN operation in the 5 GHz bands compliant with ETSI EN 301 893 [i.12], this frequency is not to be tested.</p>			

4.3.7.4 Conformance

Conformance tests as defined in clause 5.4.9 shall be carried out.

4.3.8 Receiver selectivity

4.3.8.1 Definition

Receiver selectivity is a measure of the capability of the equipment to receive a wanted signal on its channel without exceeding a given degradation due to the presence of an interfering signal in an adjacent channel or alternate adjacent channel within the operating band given in table 1.

4.3.8.2 Performance criteria

For equipment that supports a PER or FER test to be performed, the minimum performance criterion shall be a PER or FER less than or equal to 10 %.

For equipment that does not support a PER or a FER test to be performed, the minimum performance criterion shall be no loss of the wireless transmission function needed for the intended use of the equipment.

4.3.8.3 Limits

The limits defined below apply when the equipment operates on a single 20 MHz channel and the interfering signal falls completely within the adjacent or alternate adjacent 20 MHz channels.

While maintaining the minimum performance criteria as defined in clause 4.3.8.2, the interferer signal power level shall be equal to or greater than the limit given in table 11 corresponding to a frequency offset within the range specified in table 11.

Table 11: Receiver selectivity parameters

Wanted signal mean power from companion device (dBm)	Interferer signal frequency offset (MHz)	Interferer signal power (dBm) (see note 2 and note 3)	Type of interferer signal
$P_{\min} + 10$ dB	20 (see note 4)	$P_{\min} + 26$ dB	Same as the wanted signal with an equivalent nominal bandwidth
$P_{\min} + 10$ dB	40 (see note 4)	$P_{\min} + 32$ dB	Same as the wanted signal with an equivalent nominal bandwidth
<p>NOTE 1: P_{\min} is the minimum level of the wanted signal (in dBm) required to meet the minimum performance criteria as defined clause 4.3.8.2 in the absence of any interfering signal.</p> <p>NOTE 2: The levels are specified at the UUT antenna connector(s). In case of radiated measurements on a UUT with an integral antenna equipment without external (temporary) antenna connector(s) provided, the equivalent Power Flux Density (PFD) at the UUT is the ratio of the level specified and the antenna area of the UUT antenna. In case of radiated measurements with a substitution antenna, the equivalent PFD at the said antenna is the ratio of the level specified and the antenna area of the substitution antenna.</p> <p>NOTE 3: The level specified for the interferer signal applies at the lowest data rate.</p> <p>NOTE 4: The requirement applies with one interferer signal confined within the range 5 945 MHz to 6 425 MHz for interferer frequencies on either side of the wanted signal. The interferer signal frequency offset is the absolute value of the frequency separation between the interferer centre frequency and the nominal centre frequency of the wanted signal. If the manufacturer decides to make use of the permitted frequency offset of the nominal centre frequency of the wanted signal as specified in clause 4.3.1.3, a maximum offset of the interferer centre frequency offset of ± 200 kHz from the said nominal centre frequencies and a resulting offset of the interferer signal frequency offset of up to ± 400 kHz are also permitted.</p>			

4.3.8.4 Conformance

Conformance tests as defined in clause 5.4.10 shall be carried out.

4.3.9 Mechanical and electrical design

4.3.9.1 Power feeding

4.3.9.1.1 Description of types of power supply

Equipment is powered either via a wired power connection or battery powered depending on the requirements to conform to for the categories and sub-categories of equipment set out in clause 4.2.

4.3.9.1.2 Wired power connection equipment

LPI AP/bridge sub-category devices shall be supplied from a wired connection and shall not be battery powered.

4.3.9.2 Antenna design

4.3.9.2.1 Description of types of antenna design

Equipment is designed with integral antenna or dedicated antenna depending on the requirements to conform to for the categories and sub-categories of equipment set out in clause 4.2.

4.3.9.2.2 Integral antenna

LPI AP/bridge sub-category devices shall be designed with one or more integral antenna(s) as a fixed part of the equipment, i.e. without externally accessible connectors to prevent the connection of another antenna by a user.

4.3.9.3 Conformance

Conformance inspection as defined in clause 5.4.11 shall be carried out.

4.3.10 User Access Restrictions

4.3.10.1 Definition

As certain parameters are deemed to be critical in the mitigation of interference to other radio services, these parameters listed in clause 4.3.10.2 are subject to User Access Restrictions (UAR).

UAR are intended to ensure that the defined value or range of values, settings and functions for the identified parameters cannot be altered by any software or hardware element in the field by the user to any value that falls outside of the range of values detailed in the appropriate clauses within the present document.

NOTE: The user should be understood as to include the end user, the operator or any person not responsible for the conformity of the equipment against the requirements in the present document.

In addition, any hardware element that can be activated by the user to change the identified parameters in clause 4.3.10.2 is also subject to the requirements of this clause.

4.3.10.2 Requirements

The equipment shall be so constructed that settings (hardware and/or software) are not accessible to the user if changing those settings results in the equipment no longer being conformant to the following:

- The channel access mechanism requirements, as defined in clause 4.3.6, in particular the ED thresholds defined in clause 4.3.6.3.3.
- Integral antenna requirement in clause 4.3.9.2.2 for LPI AP/bridge sub-category devices.

The UUT shall be deemed to conform to the UAR requirements of the present document if the UUT does not provide options that allow automatic or manual adjustment of limits and/or requirements for those items identified above.

4.3.10.3 Conformance

Conformance assessment as defined in clause 5.4.13 shall be carried out.

5 Testing for compliance with technical requirements

5.1 Environmental conditions for testing

5.1.1 Introduction

Tests defined in the present document shall be carried out at representative points within the boundary limits of the operational environmental profile defined by its intended use, see clause 5.4.1, item f).

Where technical performance varies subject to environmental conditions, tests shall be carried out under a sufficient variety of environmental conditions (within the boundary limits of the operational environmental profile defined by its intended use) to give confidence of compliance for the affected technical requirements.

For each test defined in the present document, the environmental condition(s) at which the test has to be performed is specified in the clause on test conditions for that particular test.

5.1.2 Normal test conditions

5.1.2.1 Normal temperature and humidity

The normal temperature and humidity conditions for tests shall be any convenient combination of temperature and humidity within the following ranges:

- temperature: +15 °C to +35 °C;
- relative humidity: 20 % to 75 %.

The actual values during the tests shall be recorded.

5.1.2.2 Normal power source

The normal test voltage for the equipment shall be the nominal voltage for which the equipment was designed.

5.1.3 Extreme test conditions

Where testing under extreme test conditions is required in the present document, measurements shall be performed at both the lower extreme temperature and the upper extreme temperature.

Unless otherwise specified by the intended use of the equipment (see clause 5.4.1, item f)), the lower extreme temperature shall be -20 °C and the upper extreme temperature shall be +55 °C.

The lower extreme temperature and the upper extreme temperature may be specified by the operating temperature range as required by the intended use of the equipment (see clause 5.4.1, item f)). The lower extreme temperature shall not be higher than +15 °C and the upper extreme temperature shall not be lower than +35 °C.

The extreme temperatures used in the actual measurements shall be recorded in the test report.

5.2 Interpretation of the measurement results

The information provided in annex D can be used for the interpretation of the results recorded in a test report for the measurements described in the present document.

5.3 Definition of other test conditions

5.3.1 Test sequences

All the tests in the present document shall be performed by using a test transmission sequence that shall consist of regularly transmitted packets (e.g. with an interval of 2 ms). The test transmissions shall be fixed in length in a sequence and shall exceed the transmitter minimum activity ratio of 10 %.

The general structure of the test transmission sequence is shown in figure 7.

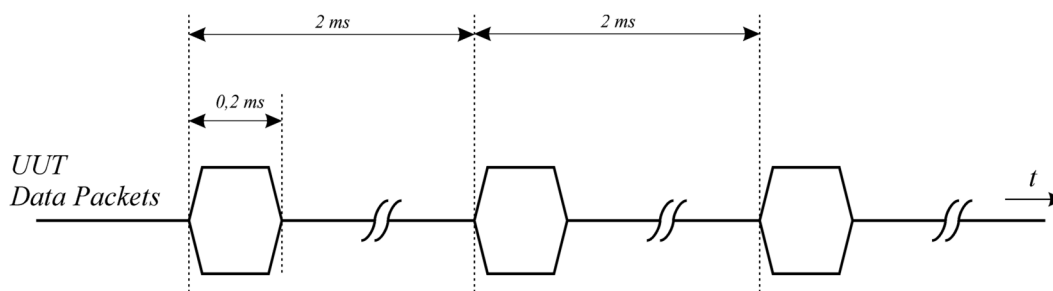

Figure 7: General structure of the test transmission sequences

5.3.2 Test channels

Unless otherwise stated in the test procedures for essential radio test suites the channels (and nominal bandwidths) on which the essential radio test suites contained in the present document shall be performed are given in table 12.

VLP equipment making use of clause 4.3.3.3 may allow a single transmit frequency to be selected manually to facilitate some of the tests to be performed.

Table 12: Test channels

Test	Clause	Channel
Nominal centre frequencies	5.4.2	One of the supported channels.
RF output power	5.4.3	The lowest and highest supported channel for every nominal bandwidth. For VLP NB operation see note 2 below.
PSD	5.4.4	The lowest and highest supported channel for the lowest nominal bandwidth. For VLP NB operation see note 2 below.
Transmitter unwanted emissions outside the 6 GHz WAS/RLAN band	5.4.5	Out-of-band domain: The lowest and highest supported channel for every nominal bandwidth. For VLP NB operation see note 2 below. Spurious domain: One of the supported channels. For VLP NB operation see note 1 below.
Transmitter unwanted emissions within the 6 GHz WAS/RLAN band	5.4.6	For single channel operation: the lowest and highest supported channels for the 20 MHz nominal bandwidth. For VLP NB operation see note 2 below. For multi-channel operation in adjacent channels: where transmission occurs in all adjacent channels the lowest and highest supported channel for every nominal bandwidth (N). For multi-channel operation in adjacent channels where one or more of the adjacent channels is not used for transmission the highest supported channel for the highest nominal bandwidth. Channel transmission configurations to show each of the supported masks in figure 2, figure 3 and figure 4. For multi-channel operation in non-adjacent channels: each set of grouped channels will be treated individually and testing is covered by the multi-channel operation in adjacent channels above.
Receiver spurious emissions	5.4.7	One of the supported channels. For VLP NB operation see note 1 below.

Test	Clause	Channel
Channel access mechanism	5.4.8	One channel (in case of single channel testing) or a group of channels (in case of multi-channel testing) out of the supported channels. For VLP NB operation see note 1 below.
Receiver blocking	5.4.9	The lowest and the highest supported channels at the lowest supported nominal bandwidth, see also clause 5.4.9.1. For VLP NB operation see note 2 and note 3 below.
Receiver selectivity	5.4.10	The lowest and the highest supported channels within the range 5 985 MHz to 6 385 MHz at the lowest supported nominal bandwidth, see also clause 5.4.10.1. For VLP NB operation see note 2 and note 3 below.
Mechanical and electrical design	5.4.11	Not applicable. Visual inspection only.
VLP NB operation with a PSD exceeding 1 dBm/MHz	5.4.12	For duty cycle measurements: See note 2. For number of hop frequency measurements: Normal operational mode with no blacklisting.
User Access Restrictions	5.4.13	Not applicable. Visual inspection only.
<p>NOTE 1: For VLP NB operation one of the supported centre frequencies, see clause 5.4.1, item b).</p> <p>NOTE 2: For VLP NB operation test 1) the lowest supported centre frequency within the lowest 20 MHz channel where NB transmissions occur and 2) the highest supported centre frequency within the highest 20 MHz channel where NB transmissions occur. These NB transmissions shall be tested at the centre frequencies at all the bandwidths for these NB transmissions, see also clause 5.4.1 item b).</p> <p>NOTE 3: Receiver blocking and receiver selectivity need only be tested at the lowest supported transmission bandwidth. For receiver selectivity the lowest and highest supported centre frequencies are selected from within the range 5 985 MHz to 6 385 MHz. Receiver blocking and receiver selectivity may be tested in normal operational mode (potentially using multiple hop frequencies).</p>		

5.3.3 Antennas

5.3.3.1 Integrated and dedicated antennas

The equipment can have either integral antennas or dedicated antennas. Dedicated antennas, further referred to as dedicated external antennas, are antennas that are physically external to the equipment and are assessed in combination with the equipment against the requirements in the present document. It should be noted that assessment does not necessarily lead to testing.

An antenna assembly referred to in the present document is understood as the combination of the antenna (integral or dedicated), its coaxial cable and if applicable, its antenna connector and associated switching components. The gain of an antenna assembly G in dBi, does not include the additional gain that may result out of beamforming.

Smart antenna systems may use beamforming techniques which may result in additional (antenna) gain. This beamforming gain Y is specified in dB. Beamforming gain does not include the gain of the antenna assembly G .

Although the measurement methods in the present document allow conducted measurements to be performed, it should be noted that the equipment together with all its intended antenna assemblies shall conform to the applicable technical requirements defined in the present document.

5.3.3.2 Transmit operating modes

5.3.3.2.1 Operating mode 1 (single antenna)

The equipment uses only one antenna when operating in this mode.

The following types of equipment and/or operating modes are examples covered by this category:

- Equipment with only one antenna.
- Equipment with two diversity antennas but at any moment in time only one antenna is used.
- Smart antenna system with two or more antennas but operating in a mode where only one antenna is used.

5.3.3.2.2 Operating mode 2 (multiple antennas, no beamforming)

The equipment that can operate in this mode contains a smart antenna system using two or more transmit chains simultaneously but without beamforming.

5.3.3.2.3 Operating mode 3 (multiple antennas, with beamforming)

The equipment that can operate in this mode contains a smart antenna system using two or more transmit chains simultaneously with beamforming.

In addition to the antenna assembly gain G , the beamforming gain Y may have to be taken into account when performing the measurements described in the present document.

5.3.4 Presentation of equipment

Stand-alone equipment shall be tested against all requirements of the present document.

For testing combined or multi-radio equipment against the requirements of the present document, specific guidance is given by ETSI EG 203 367 [i.4], clause 6.

It shall be noted in the test report whether his equipment is stand-alone equipment, combined equipment or multi-radio equipment, see clause 5.4.1, item h).

5.3.5 Measurement methods

Either conducted or radiated measurements may be used.

For integral antenna equipment, connectors may be provided to allow conducted measurements to be performed.

In the case of integral antenna equipment that has no antenna connector(s), the manufacturer may be required to supply a test fixture, to allow relative, normalized and level independent measurements to be made. The measurement methods allowed are specific to the test case and are given in table 13.

The test fixture and its use are further described in clause B.4.

Table 13: Measurement methods allowed

Test case	Conducted with connector on UUT	Radiated	Test fixture relative	Test fixture normalized	Test fixture level independent
Nominal centre frequencies	Yes	Yes	Yes	Yes	Yes
RF output power	Yes	Yes	Yes	Yes	No
PSD	Yes	Yes	Yes	Yes	No
Transmitter unwanted emissions outside the 6 GHz WAS/RLAN band	Yes	Yes	No	No	No
Transmitter unwanted emissions within the 6 GHz WAS/RLAN band	Yes	Yes	No	Yes	No
Receiver spurious emissions	Yes	Yes	No	No	No
Channel access mechanism	Yes	Yes	No	Yes	No
Receiver blocking	Yes	Yes	No	Yes	No
Receiver selectivity	Yes	Yes	No	Yes	No
VLP NB operation with a PSD exceeding 1 dBm/MHz (Duty cycle/Number of hop frequencies)	Yes	Yes	No	Yes	Yes

5.4 Essential radio test suites

5.4.1 Product information

The information requested in this clause shall be included in the test report. This information is required in order to carry out the test suites to the technical requirements in the present document:

- a) The different device type categories (e.g. LPI, VLP) in which the equipment can operate (see clause 4.2):
 - for a VLP device, whether it transmits at a PSD exceeding 1 dBm/MHz (see clause 4.3.3.3).
- b) The channel plan(s), being the nominal centre frequencies and the associated nominal bandwidth(s):
 - for a VLP device that transmits at a PSD exceeding 1 dBm/MHz (see clause 4.3.3.3), the centre frequencies at which the device will be transmitting with a PSD exceeding 1 dBm/MHz and the bandwidth(s) of these transmissions.
- c) If the equipment can support multi-channel operation (see clause 4.3.6.3.1.3 and clause 4.3.6.3.2.3) the following shall be provided:
 - the maximum number of channels that can be used for the multi-channel operation;
 - whether or not these channels are adjacent or non-adjacent;
 - whether the equipment supports a multi-channel configuration using a group of adjacent channels (per clause 4.3.4.3.2.2) or non-adjacent groups of adjacent channels (per clause 4.3.4.3.2.3) or both;
 - where there may be channels not used for transmission in multi-channel operation within a group of adjacent channels, which channel edge masks (i.e. figure 2, figure 3 and figure 4 from clause 4.3.4.3.2.2) are supported by the equipment;
 - whether the LBE uses option 1 and/or option 2 (see clause 4.3.6.3.2.3) for its multi-channel operation;
 - for LBE implementing option 1, the number of channels used for multi-channel operation when performing the test described in clause 5.4.8.3.2.3.1.
- d) The different transmit operating modes in which the equipment can operate (see clause 5.3.3.2).
- e) For each of the modes noted under d) the following shall be provided:
 - the number of transmit chains;
 - if more than one transmit chain is active, whether the power is distributed equally or not;
 - the number of receive chains;
 - whether or not antenna beamforming is implemented, and if so the maximum beamforming gain Y for this transmit operating mode;
 - the maximum transmitter output power level (or maximum EIRP level in case of integrated antenna equipment);
 - in case of smart antenna systems with different transmitter operating modes (see clause 5.3.3.2) the transmitter output power levels may differ depending on the operating mode;
 - the intended antenna assembly(ies), their corresponding maximum gain(s) G, the resulting EIRP values (taking also into account the beamforming gain Y if applicable).
- f) The operating temperature range that applies to the intended use of the equipment, if different from -20 °C to +55 °C.
- g) The test sequence/test software used by the equipment.
- h) Type of equipment: stand-alone equipment, combined equipment or multi-radio equipment.

- i) With regards to the channel access mechanism, whether the equipment is Frame Based Equipment (FBE) or Load Based Equipment (LBE).
- j) With regards to channel access mechanism for FBE:
 - whether the FBE operates as an initiating device and/or as a responding device, see clause 4.3.6.3.1.2;
 - the FFP(s) implemented by the FBE.
- k) With regards to channel access mechanism for LBE:
 - whether the LBE operates as a supervising device and/or as a supervised device, see clause 4.3.6.3.2.2;
 - whether the LBE makes use of note 1 in table 7 or note 1 in table 8;
 - if the LBE is a supervising device, whether the equipment is capable to make use of note 2 in table 7;
 - whether the LBE operates as an initiating device and/or as a responding device, see clause 4.3.6.3.2.5 and clause 4.3.6.3.2.6;
 - all the priority classes implemented by the LBE, see clause 4.3.6.3.2.4.
- l) Where applicable, the minimum performance criteria (see clause 4.3.7.2 and clause 4.3.8.2) that corresponds to the intended use of the equipment.
- m) The theoretical maximum radio performance of the equipment (e.g. maximum throughput).

5.4.2 Nominal centre frequencies

5.4.2.1 Test conditions

These measurements shall be performed under both normal and extreme test conditions (see clause 5.1.2 and clause 5.1.3).

The UUT shall be configured to operate at a normal RF output power level. In addition, the UUT shall be configured to operate on a single channel.

For a UUT with antenna connector(s) and using dedicated external antenna(s), or for a UUT with integral antenna(s) but with a temporary antenna connector(s) provided, conducted measurements shall be used.

In case of conducted measurements on smart antenna systems (devices with multiple transmit chains) the measurements shall be performed on only one of the active transmit chains.

For a UUT with integral antenna(s) and without a temporary antenna connector(s), radiated measurements shall be used.

In the case of equipment intended for use with an integral antenna and where no external (temporary) antenna connectors are provided, a test fixture as described in clause B.4 may be used to perform relative measurements at the lower and upper extreme temperatures.

5.4.2.2 Test methods

5.4.2.2.1 Conducted measurement

5.4.2.2.1.1 Equipment operating without modulation

This test method requires that the UUT can be operated in an unmodulated test mode.

The UUT shall be connected to a suitable frequency measuring device (e.g. a frequency counter or a spectrum analyser) and operated in an unmodulated mode.

The result shall be recorded.

5.4.2.2.1.2 Equipment operating with modulation

This method is an alternative to the above method in case the UUT cannot be operated in an unmodulated mode.

The UUT shall be connected to spectrum analyser.

Max Hold shall be selected and the centre frequency adjusted to that of the channel at which the transmission to be investigated occurs.

The peak value of the power envelope shall be measured and noted. The span shall be reduced and the marker moved in a positive frequency increment until the upper, (relative to the centre frequency), -10 dBc point is reached. This value shall be noted as f1.

The marker shall then be moved in a negative frequency increment until the lower, (relative to the centre frequency), -10 dBc point is reached. This value shall be noted as f2.

The nominal centre frequency is calculated as $(f1 + f2) / 2$.

5.4.2.2.2 Radiated measurement

The test set up as described in annex B shall be used with a spectrum analyser attached to the test antenna.

The test procedure is as described under clause 5.4.2.2.1.

5.4.2.2.3 Test fixture measurement

The test set up and the procedure as described in clause B.4 shall be used with the spectrum analyser attached to the test fixture.

The test procedure is further as described under clause 5.4.2.2.1.

5.4.3 RF output power

5.4.3.1 Test conditions

These measurements shall be performed under both normal and extreme test conditions (see clause 5.1.2 and clause 5.1.3).

The measurements described in the present clause may need to be repeated to cover each of the transmit operating modes and corresponding antenna assemblies supported by the equipment (see clause 5.3.3.2 and clause 5.4.1, item d) and item e)).

The measurements shall be performed with test signal specified in clause 5.3.1 applied. Alternatively, if special test functions are available, the equipment may also be configured in a continuous transmit mode or with a constant duty cycle (e.g. frame based systems) which is at least 10 %.

For a UUT with antenna connector(s) and using dedicated external antenna(s), or for a UUT with integral antenna(s) but with temporary antenna connector(s) provided, conducted measurements may be used in conjunction with the stated antenna assembly gain(s).

In the case of equipment intended for use with an integral antenna and where no external (temporary) antenna connectors are provided, a test fixture as described in clause B.4 may be used to perform relative measurements at the lower and upper extreme temperatures.

5.4.3.2 Test methods

5.4.3.2.1 Conducted measurement

5.4.3.2.1.1 Additional test conditions

For equipment that can be configured to operate in a continuous transmit mode or with a constant duty cycle (x) procedure 1 (see clause 5.4.3.2.1.2) shall be performed.

For equipment that has non-continuous transmissions and cannot be configured to transmit continuously or with a constant duty cycle (x) procedure 2 (see clause 5.4.3.2.1.3) shall be performed.

The UUT shall be configured to operate at the maximum RF output power level.

5.4.3.2.1.2 Procedure 1

Step 1:

For equipment configured into a continuous transmit mode ($x = 1$), proceed immediately with step 2.

- The output power of the transmitter shall be coupled to a matched diode detector or equivalent thereof. The output of the diode detector shall be connected to the vertical channel of an oscilloscope.
- The combination of the diode detector and the oscilloscope shall be capable of faithfully reproducing the duty cycle of the transmitter output signal.
- The observed duty cycle of the transmitter ($TxOn / (TxOn + TxOff)$) shall be noted as x ($0 < x \leq 1$), and recorded in the test report.

Step 2:

- The RF output power shall be determined using a wideband RF power meter with a thermocouple detector or an equivalent thereof and with an integration period that exceeds the repetition period of the transmitter by a factor of 5 or more. The observed value shall be noted as A (in dBm).
- In case of conducted measurements on smart antenna systems operating in a mode with multiple transmit chains active simultaneously, the output power of each transmit chain shall be measured separately to calculate the total power (value A in dBm) for the UUT.

Step 3:

- The RF output power (P_{max}) shall be calculated from the above measured power output A (in dBm), the observed duty cycle x , the stated antenna gain G in dBi and if applicable the beamforming gain Y in dB, according to the formula below. If more than one antenna assembly is intended for this power setting the gain of the antenna assembly with the highest gain shall be used.

$$P_{max} = A + G + Y + 10 \times \log(1/x) \text{ (dBm)}.$$

- This value P_{max} shall be compared to the applicable limit and shall be recorded in the test report.

5.4.3.2.1.3 Procedure 2

Step 1:

- Sample the transmit signal from the UUT using a fast power sensor suitable for up to 7 GHz. Save the raw samples. The samples shall represent the RMS power of the signal.
- Settings:
 - Sample speed: $\geq 10^6$ samples/s.
 - Measurement duration: Sufficient to capture a minimum of 10 transmitter bursts (see clause 5.3.1).

Step 2:

- For conducted measurements on devices with one transmit chain:
 - Connect the power sensor to the transmit port, sample the transmit signal and store the raw data. Use these stored samples in all following steps.
- For conducted measurements on devices with multiple transmit chains:
 - Connect a power sensor to each transmit port for a synchronous measurement on all transmit ports.
 - Trigger the power sensors so that they start sampling at the same time. Make sure the time difference between the samples of all sensors is less than 500 ns.
 - For each individual sampling point (time domain), sum the coincident power samples of all ports and store them. Use these summed samples in the following steps.

Step 3:

- Find the start and stop times of each burst in the stored measurement samples.
- The start and stop times are defined as the points where the power is at least 30 dB below the highest value of the stored samples in step 2.
- In case of insufficient dynamic range, the value of 30 dB may need to be reduced appropriately.

Step 4:

- Between the start and stop times of each individual burst, calculate the RMS (mean) power over the burst (P_{burst}) using the formula below:

$$P_{burst} = \frac{1}{k} \sum_{n=1}^k P_{sample}(n)$$

with k the total number of samples and n the actual sample number

- The highest of all P_{burst} values is the value A in dBm.

Step 5:

- The RF output power level P_{max} shall be calculated from the above measured power output A (in dBm), the stated antenna assembly gain G in dBi and if applicable the beamforming gain Y in dB, according to the formula below. If more than one antenna assembly is intended for this power setting, the gain of the antenna assembly with the highest gain shall be used:

$$P_{max} = A + G + Y \text{ (dBm)}$$

- This value P_{max} shall be compared to the applicable limit and shall be recorded in the test report.

5.4.3.2.2 Radiated measurement

When performing radiated measurements on a UUT with a directional antenna (including smart antenna systems and systems capable of beamforming), the UUT shall be configured/positioned for maximum EIRP towards the measurement antenna and in the horizontal plane. This configuration/position shall be recorded for future use (see clause 5.4.9.2.2 and clause C.5.2.4).

A test site as described in annex B and using the applicable measurement procedures as described in annex C shall be used.

The test procedure is further as described under clause 5.4.3.2.1. However, the following shall be taken into account when performing radiated measurements.

For measuring RF output power:

- When using procedure 1 as in clause 5.4.3.2.1.2 the values G and Y used in step 3 shall be ignored.

- When using procedure 2 as in clause 5.4.3.2.1.3 the values G and Y used in step 5 shall be ignored.

5.4.3.2.3 Test fixture measurement

The test set up and the normalization procedure as described in clause B.4.4 shall be used with the measuring device attached to the fixture.

In the case of equipment intended for use with an integral antenna and where no external (temporary) antenna connectors are provided, a test fixture as described in clause B.4 may be used to perform relative measurements at the lower and upper extreme temperatures.

The test procedure is further as described under clause 5.4.3.2.1.

5.4.4 Power Spectral Density

5.4.4.1 Test conditions

These measurements shall only be performed at normal test conditions (see clause 5.1.2).

The measurements described in the present clause may need to be repeated to cover each of the transmit operating modes and corresponding antenna assemblies supported by the equipment (see clause 5.3.3.2 and clause 5.4.1, item d) and item e)).

The measurements shall be performed with test signal specified in clause 5.3.1 applied. Alternatively, if special test functions are available, the equipment may also be configured in a continuous transmit mode or with a constant duty cycle (e.g. frame based systems) which is at least 10 %.

For a UUT with antenna connector(s) and using dedicated external antenna(s), or for a UUT with integral antenna(s) but with temporary antenna connector(s) provided, conducted measurements may be used in conjunction with the stated antenna assembly gain(s).

The UUT shall be configured to operate at the lowest nominal bandwidth with the maximum RF output power level.

5.4.4.2 Test methods

5.4.4.2.1 Conducted measurement

5.4.4.2.1.1 Additional test conditions

For equipment that can be configured to operate in a continuous transmit mode or with a constant duty cycle (x) procedure 1 (see clause 5.4.4.2.1.2) shall be performed.

For equipment that has non-continuous transmissions and cannot be configured to transmit continuously or with a constant duty cycle (x) procedure 2 (see clause 5.4.4.2.1.3) shall be performed.

5.4.4.2.1.2 Procedure 1

Step 1:

- Connect the UUT to the spectrum analyser and use the following settings:
 - Centre frequency: Centre frequency of the channel or VLP NB transmission to be investigated
 - RBW: 1 MHz
 - VBW: 3 MHz
 - Frequency span: $2 \times$ nominal bandwidth (e.g. 40 MHz for a 20 MHz channel)
 - Detector mode: Peak
 - Trace mode: Max Hold

Step 2:

- When the trace is complete, find the peak value of the power envelope and record the frequency.

Step 3:

- Make the following changes to the settings of the spectrum analyser:
 - Centre frequency: The frequency recorded in step 2
 - Frequency span: 3 MHz
 - RBW: 1 MHz
 - VBW: 3 MHz
 - Sweep time: 1 minute
 - Detector mode: RMS
 - Trace mode: Max Hold

Step 4:

- When the trace is complete, the trace shall be captured using the "Hold" or "View" option on the spectrum analyser.
- Find the peak value of the trace and place the analyser marker on this peak. This level is recorded as the highest mean power (PSD) D in a 1 MHz band.
- Alternatively, where a spectrum analyser is equipped with a function to measure PSD, this function may be used to display the PSD, D in dBm/MHz.
- In case of conducted measurements on smart antenna systems operating in a mode with multiple transmit chains active simultaneously, the PSD of each transmit chain shall be measured separately to calculate the total PSD (value D in dBm/MHz) for the UUT.

Step 5:

- The maximum Power Spectral Density (PD) is calculated from the above measured Power Spectral Density D, the observed duty cycle x (see clause 5.4.3.2.1.2, step 1), the applicable antenna assembly gain G in dBi and if applicable the beamforming gain Y in dB, according to the formula below. If more than one antenna assembly is intended for this power setting, the gain of the antenna assembly with the highest gain shall be used:

$$PD = D + G + Y + 10 \times \log (1 / x) \text{ (dBm/MHz)}$$

Step 6:

- The values for the maximum PSD obtained in step 5 shall conform to the applicable limits and shall be recorded in the test report.

5.4.4.2.1.3 Procedure 2

Step 1:

- Connect the UUT to the spectrum analyser and use the following settings:
 - Start frequency: Lower band edge of 5 945 MHz
 - Stop frequency: Upper band edge of 6 425 MHz
 - RBW: 10 kHz
 - VBW: 30 kHz

- Sweep points: > 50 000 (for 5 945 MHz to 6 425 MHz)
For spectrum analysers not supporting this number of sweep points, the frequency band may be segmented.
 - Detector mode: RMS
 - Trace mode: Max Hold
 - Sweep time: 30 s
- For non-continuous signals, wait for the trace to be stabilized. Save the (trace) data set to a file.

Step 2:

- For conducted measurements on smart antenna systems using either operating mode 2 or operating mode 3 (see clause 5.3.3.2), repeat the measurement for each of the transmit ports. For each sampling point (frequency domain), add up the coincident power values (in mW) for the different transmit chains and use this as the new data set.

Step 3:

- Add up the values of power for all the samples in the file using the formula below:

$$P_{\text{sum}} = \sum_{n=1}^k P_{\text{sample}}(n)$$

with k the total number of samples and n the actual sample number

Step 4:

- Normalize the individual values for power (in dBm) so that the sum is equal to the RF output power (P_{max}) measured in clause 5.4.3.2.1. The following formulas can be used:

$$C_{\text{Corr}} = P_{\text{sum}} - P_H$$

$$P_{\text{samplecorr}}(n) = P_{\text{sample}}(n) - C_{\text{corr}}$$

with n the actual sample number

Step 5:

- Starting from the first sample $P_{\text{samplecorr}}(n)$ in the file (lowest frequency), add up the power (in mW) of the following samples representing a 1 MHz segment and record the results for power and position (i.e. sample #1 to sample #100). This is the PSD for the first 1 MHz segment which shall be saved.

Step 6:

- Shift the start point of the samples added up in step 5 by one sample and repeat the procedure in step 5 (i.e. sample #2 to sample #101).

Step 7:

- Repeat step 6 until the end of the data set and save the radiated PSD values for each of the 1 MHz segments.
- From all the saved results, the highest value is the maximum PSD for the UUT.

Step 8:

- The values for the maximum PSD obtained in step 7 shall conform to the applicable limits and shall be recorded in the test report.

5.4.4.2.2 Radiated measurement

For measuring PSD:

- When using procedure 1 as in clause 5.4.4.2.1.2, the values G and Y used in step 5 shall be ignored.

For measuring the RF output power, it is likely that a radiated measurement would be performed using a spectrum analyser or measurement receiver, rather than a wide band power sensor. If this is the case and if the resolution bandwidth capability of the measurement device is narrower than the nominal bandwidth of the UUT signal being measured, then the method of measurement shall be documented in the test report.

5.4.4.2.3 Test fixture measurement

The test set up and the normalization procedure as described in clause B.4.4 shall be used with the measuring device attached to the fixture.

The test procedure is further as described under clause 5.4.4.2.1.

5.4.5 Transmitter unwanted emissions outside the 6 GHz WAS/RLAN band

5.4.5.1 Test conditions

These measurements shall be performed only under normal test conditions (see clause 5.1.2).

The equipment shall be configured to operate under its worst case situation with respect to unwanted emissions outside the 6 GHz WAS/RLAN band.

For VLP equipment making use of clause 4.3.3.3, the measurements may be performed on a single frequency. When this is not possible, the measurement shall be performed during normal operation.

If possible, the UUT shall be set to continuous transmit (duty cycle = 1) for the duration of this test.

If continuous transmit is not possible, the UUT should be configured to operate at its maximum duty cycle.

The level of transmitter unwanted emissions shall be measured as, either:

- a) their power in a specified load (conducted emissions) and their radiated power (ERP for emissions up to 1 GHz and EIRP for emissions above 1 GHz) when radiated by the cabinet or structure of the equipment (cabinet radiation); or
- b) their radiated power (ERP for emissions up to 1 GHz and EIRP for emissions above 1 GHz) when radiated by cabinet and antenna.

5.4.5.2 Test method

5.4.5.2.1 Conducted measurement

5.4.5.2.1.1 Pre-scan

The UUT shall be connected to a spectrum analyser capable of RF power measurements.

This pre-scan test procedure shall be used to identify potential unwanted emissions of the UUT in either the out-of-band or spurious domains.

Step 1:

- The sensitivity of the spectrum analyser should be such that the noise floor is at least 12 dB below the applicable limits.

Step 2:

- The unwanted emissions over the range 30 MHz to 1 000 MHz shall be identified.

- Spectrum analyser settings:

- RBW: 100 kHz
- VBW: 300 kHz
- Detector mode: Peak
- Trace mode: Max Hold
- Sweep points: $\geq 9\,700$

For spectrum analysers not supporting this number of sweep points, the frequency band may be segmented. For spectrum analysers capable of supporting twice this number of sweep points, the frequency adjustment in clause 5.4.5.2.1.2 (step 1, last bullet) may be omitted.

- Sweep time: For non-continuous transmissions (duty cycle less than 100 %), the sweep time shall be sufficiently long, such that for each 100 kHz frequency step, the measurement time is greater than two transmissions of the UUT.

EXAMPLE 1: For non-continuous transmissions, if the UUT is using a test sequence as described in clause 5.3.1 with a transmitter TxOn + TxOff time of 2 ms, then the sweep time has to be greater than 4 ms per 100 kHz.

- Allow the trace to stabilize. Any emissions identified that have a margin of less than 6 dB with respect to the applicable limit shall be individually measured using the procedure in clause 5.4.5.2.1.2 and compared to the applicable limit.

Step 3:

- The unwanted emissions over the range 1 GHz to 26 GHz shall be identified.

- Spectrum analyser settings:

- RBW: 1 MHz
- VBW: 3 MHz
- Detector mode: Peak
- Trace mode: Max Hold
- Sweep points: $\geq 25\,000$

For spectrum analysers not supporting this number of sweep points, the frequency band may be segmented. For spectrum analysers capable of supporting twice this number of sweep points, the frequency adjustment in clause 5.4.5.2.1.2 (step 1, last bullet) may be omitted.

- Sweep time: For non-continuous transmissions (duty cycle less than 100 %), the sweep time shall be sufficiently long, such that for each 1 MHz frequency step, the measurement time is greater than two transmissions of the UUT.

EXAMPLE 2: For non-continuous transmissions, if the UUT is using a test sequence as described in clause 5.3.1 with a transmitter TxOn + TxOff time of 2 ms, then the sweep time has to be greater than 4 ms per 1 MHz.

- Allow the trace to stabilize. Any emissions identified that have a margin of less than 6 dB with respect to the applicable limits shall be individually measured using the procedure in clause 5.4.5.2.1.2 and compared to the applicable limits.

5.4.5.2.1.2 Measurement of the emissions identified during the pre-scan

The limits for Transmitter unwanted emissions refer to average power levels.

The steps below shall be used to accurately measure the individual unwanted emissions identified in either the out-of-band or spurious domains during the pre-scan measurements above.

Continuous transmit signals:

For continuous transmit signals, a simple measurement using the RMS detector of the spectrum analyser is permitted. The measured values shall be recorded and compared with the applicable limit.

Non-continuous transmit signals:

For non-continuous transmit signals, the measurement shall be made using the RMS detector of the spectrum analyser only over the "TxOn" part of the burst.

Step 1:

- The level of the emissions shall be measured in the time domain, using the following spectrum analyser settings:
 - Centre frequency: Frequency of emission identified during the pre-scan
 - RBW: 100 kHz (≤ 1 GHz) / 1 MHz (> 1 GHz)
 - VBW: 300 kHz (≤ 1 GHz) / 3 MHz (> 1 GHz)
 - Frequency span: 0 Hz
 - Sweep mode: Single sweep
 - Sweep time: Suitable to capture one transmission burst. Additional measurements may be needed to identify the length of the transmission burst. In case of continuous signals, the sweep time shall be set to 30 ms
 - Sweep points: Sweep time (μ s) / 1 μ s with a maximum of 30 000
 - Trigger mode: Video (burst signals) or Manual (continuous signals)
 - Detector mode: RMS
 - Trace mode: Clear/Write
- Adjust the centre frequency (fine tune) to capture the highest level of one burst of the emission to be measured.

This fine tuning can be omitted for spectrum analysers capable of supporting twice this number of sweep points required in step 2 and step 3 from the pre-scan procedure in clause 5.4.5.2.1.1.

Step 2:

- Adjust the trigger level to select the transmissions with the highest power level.
- Set a window (start and stop lines) to match with the start and end of the burst and in which the RMS power shall be measured using the Time Domain Power function. If the spurious emission to be measured is a continuous signal, the measurement window shall be set to match the start and stop times of the sweep.
- Select RMS power to be measured within the selected window and note the result which is the RMS power of this particular spurious emission. Compare this value with the applicable limit.

Repeat this procedure for every emission identified during the pre-scan. The values and corresponding frequencies shall be recorded.

In case of conducted measurements on smart antenna systems (equipment with multiple transmit chains), the measurements shall be repeated for each of the active transmit chains. Comparison with the applicable limits shall be done using either of the options given below:

- Option 1: the results for each of the transmit chains for the corresponding 1 MHz segments shall be added and compared with the applicable limits.
- Option 2: the results for each of the transmit chains shall be individually compared with the applicable limits after these limits have been reduced by $10 \times \log_{10}(T_{ch})$ (number of active transmit chains).

5.4.5.2.2 Radiated measurement

The test set up as described in annex B shall be used with a spectrum analyser attached to the test antenna.

The test procedure is as described under clause 5.4.5.2.1.

5.4.5.2.3 Test fixture measurement

The use of a test fixture is not allowed for testing transmitter unwanted emissions outside the 6 GHz WAS/RLAN band.

5.4.6 Transmitter unwanted emissions within the 6 GHz WAS/RLAN band

5.4.6.1 Test conditions

These measurements shall be performed only under normal test conditions (see clause 5.1.2).

The equipment shall be configured to operate under its worst case situation with respect to unwanted emissions within the 6 GHz WAS/RLAN band.

For VLP equipment making use of clause 4.3.3.3, the measurements may be performed on a single frequency or during normal operation (potentially using multiple hop frequencies). The value of N in the mask (see figure 1) shall be the nominal bandwidth as noted in the test report per clause 5.4.1, item b) within which the transmissions occur.

For UUT without an integral antenna and for a UUT with an integral antenna but with one or more temporary antenna connector(s), conducted measurements should be performed. Alternatively, if UUT has an integral antenna(s), but no temporary antenna connector(s), radiated measurements may be used.

In case of conducted measurements on smart antenna systems (devices with multiple transmit chains) operating in a mode with more than one transmit chain being active simultaneously, measurements shall only be performed on one of the transmit chains (antenna outputs).

5.4.6.2 Test method

5.4.6.2.1 Conducted measurement

5.4.6.2.1.1 Applicability

For equipment with continuous transmission capability (duty cycle equal to 100 %), the procedure specified in clause 5.4.6.2.1.2 shall be used.

For equipment without continuous transmission capability (duty cycle less than 100 %), the procedure specified in clause 5.4.6.2.1.3 shall be used.

If the relative power envelope of the UUT (from measurements using either the procedure specified in clause 5.4.6.2.1.2 or the procedure specified in clause 5.4.6.2.1.3) does not meet the limit defined for a 1 MHz measurement bandwidth:

- i) in the 0 dB (i.e. reference level of the mask) to -20 dB slope of the applied mask; or
- ii) within 500 kHz of the -20 dB point(s) of the applied mask; or
- iii) for LO exceedance defined in clause 4.3.4.3.2.2.

The procedure specified in clause 5.4.6.2.1.4 may be used in addition. This procedure may be applied to determine conformance in these regions when applying the transmit spectral power mask in figure 1 and any overall transmit spectral power mask constructed from figure 2, figure 3 and figure 4. This procedure may also be applied for multi-channel operation in non-adjacent channels as defined in clause 4.3.4.3.2.3.

5.4.6.2.1.2 Equipment with continuous transmission capability

The UUT shall be configured for continuous transmit mode (duty cycle equal to 100 %).

Step 1: Determination of the reference average power level

- Spectrum analyser settings:
 - RBW: 1 MHz
 - VBW: 30 kHz
 - Detector mode: RMS
 - Trace mode: Video Average
 - Sweep time: Coupled
 - Centre frequency: Centre frequency of the channel being investigated
 - Frequency span: $2 \times$ nominal bandwidth
- Use the marker to find the highest average power level of the power envelope of the UUT. This level shall be used as the reference level for the relative measurements.

Step 2: Determination of the relative average power levels

- Adjust the frequency range of the spectrum analyser to allow the measurement to be performed within the band of operation. No other parameter of the spectrum analyser should be changed.
- Compare the relative power envelope of the UUT with the limits defined in clause 4.3.4.3.2.

Step 3: Allowance for a 100 kHz RBW measurement procedure

- As applicable, run additional measurements per clause 5.4.6.2.1.4.

5.4.6.2.1.3 Equipment without continuous transmission capability

Step 1: Determination of the reference average power level

- Spectrum analyser settings:
 - RBW: 1 MHz
 - VBW: 30 kHz
 - Detector mode: RMS
 - Trace mode: Max Hold
 - Sweep time: ≥ 1 min
 - Centre frequency: Centre frequency of the channel being investigated
 - Frequency span: $2 \times$ nominal bandwidth
- Use the marker to find the highest average power level of the power envelope of the UUT. This level shall be used as the reference level for the relative measurements.

Step 2: Determination of the relative average power levels

- Adjust the frequency range of the spectrum analyser to allow the measurement to be performed within the band of operation. No other parameter of the spectrum analyser should be changed.
- Compare the relative power envelope of the UUT with the limits defined in clause 4.3.4.3.2.

Step 3: Allowance for a 100 kHz RBW measurement procedure

- As applicable, run additional measurements per clause 5.4.6.2.1.4.

5.4.6.2.1.4 Additional measurements using a 100 kHz RBW

Step 1: Determination of the reference average power level

- Spectrum analyser settings:
 - RBW: 100 kHz
 - VBW: 300 kHz

Otherwise the relevant settings from either clause 5.4.6.2.1.2 or clause 5.4.6.2.1.3 apply.

- Use the marker to find the highest average power level of the power envelope of the UUT. This level shall be used as the reference level for the relative measurements.

Step 2: Determination of the relative average power levels

- Adjust the frequency range of the spectrum analyser to allow the measurement to be performed within the band of operation. No other parameter of the spectrum analyser should be changed.
- Compare the relative power envelope of the UUT with the limits defined in clause 4.3.4.3.2.

5.4.6.2.2 Radiated measurement

The test set up as described in annex B shall be used with a spectrum analyser attached to the test antenna.

The test procedure is as described under clause 5.4.6.2.1.

5.4.6.2.3 Test fixture measurement

The test set up and the and normalization procedure as described in clause B.4.4 shall be used with the spectrum analyser attached to the test fixture.

The test procedure is further as described under clause 5.4.6.2.1.

5.4.7 Receiver spurious emissions**5.4.7.1 Test conditions**

These measurements shall only be performed at normal test conditions (see clause 5.1.2).

In case of equipment with antenna connectors, these limits in clause 4.3.5.2 apply to emissions at the antenna port (conducted). For emissions radiated by the cabinet or emissions radiated by integral antenna equipment (without antenna connectors), these limits are ERP for emissions up to 1 GHz and EIRP for emissions above 1 GHz.

For equipment having different operating modes (see clause 5.3.3.2) the measurements described in the present clause may not need to be repeated for all the operating modes.

The level of receiver spurious emissions shall be measured as, either:

- a) their power in a specified load (conducted emissions) and their radiated power (ERP for emissions up to 1 GHz and EIRP for emissions above 1 GHz) when radiated by the cabinet or structure of the equipment (cabinet radiation); or
- b) their radiated power (ERP for emissions up to 1 GHz and EIRP for emissions above 1 GHz) when radiated by cabinet and antenna.

The test method in clause 5.4.7.2 below assumes, that for the duration of the test, the UUT is configured into a continuous receive mode, or is operated in a mode where no transmissions occur.

5.4.7.2 Test methods

5.4.7.2.1 Conducted measurement

5.4.7.2.1.1 Pre-scan

The test procedure below shall be used to identify potential receiver spurious emissions of the UUT.

Step 1:

- The sensitivity of the spectrum analyser should be such that the noise floor is at least 12 dB below the limits given in clause 4.3.5.2, table 6.

Step 2:

- The emissions shall be measured over the range 30 MHz to 1 000 MHz.
- Spectrum analyser settings:
 - RBW: 100 kHz
 - VBW: 300 kHz
 - Detector mode: Peak
 - Trace mode: Max Hold
 - Sweep points: $\geq 9\,700$

For spectrum analysers not supporting this number of sweep points, the frequency band may be segmented. For spectrum analysers capable of supporting twice this number of sweep points, the frequency adjustment in clause 5.4.7.2.1.2 (step 1, last bullet) may be omitted.

 - Sweep time: Auto
- Wait for the trace to stabilize. Any emissions identified that have a margin of less than 6 dB with respect to the applicable limit shall be individually measured using the procedure in clause 5.4.7.2.1.2 and compared to the applicable limit.

Step 3:

- The emissions shall now be measured over the range 1 GHz to 26 GHz.
- Spectrum analyser settings:
 - RBW: 1 MHz
 - VBW: 3 MHz
 - Detector mode: Peak
 - Trace mode: Max Hold

- Sweep points: $\geq 25\ 000$

For spectrum analysers not supporting this high number of sweep points, the frequency band may need to be segmented. For spectrum analysers capable of supporting twice this number of sweep points, the frequency adjustment in clause 5.4.7.2.1.2 (step 1, last bullet) may be omitted.

- Sweep time: Auto
- Wait for the trace to stabilize. Any emissions identified that have a margin of less than 6 dB with respect to the applicable limit given in clause 4.3.5.2, table 6, shall be individually measured using the procedure in clause 5.4.7.2.1.2 and compared to the applicable limit.

5.4.7.2.1.2 Measurement of the emissions identified during the pre-scan

The limits for receiver spurious emissions refer to average power levels.

The steps below shall be used to accurately measure the individual unwanted emissions identified during the pre-scan measurements above. This method assumes the spectrum analyser has a Time Domain Power function.

Step 1:

- The level of the emissions shall be measured using the following spectrum analyser settings:
 - Measurement mode: Time Domain Power
 - Centre frequency: Frequency of the emission identified during the pre-scan
 - RBW: 100 kHz if ≤ 1 GHz; 1 MHz if > 1 GHz
 - VBW: 300 kHz if ≤ 1 GHz; 3 MHz if > 1 GHz
 - Frequency span: 0 Hz
 - Sweep mode: Single sweep
 - Sweep time: 30 ms
 - Sweep points: $\geq 30\ 000$
 - Trigger mode: Video (for burst signals) or Manual (for continuous signals)
 - Detector mode: RMS
- Adjust the centre frequency (fine tune) to capture the highest level of one burst of the emission to be measured.

This fine tuning can be omitted for spectrum analysers capable of supporting twice this number of sweep points required in step 2 and step 3 from the pre-scan procedure in clause 5.4.7.2.1.1.

Step 2:

- Set a window where the start and stop indicators match the start and end of the burst with the highest level and record the value of the power measured within this window.
- If the spurious emission to be measured is a continuous transmission, the measurement window shall be set to the start and stop times of the sweep.

Step 3:

- In case of conducted measurements on smart antenna systems (equipment with multiple receive chains), step 2 shall be repeated for each of the active receive chains.
- Sum the measured power (within the observed window) for each of the active receive chains.

Step 4:

- The value defined in step 3 shall be compared to the applicable limit.

5.4.7.2.2 Radiated measurement

The test set up as described in annex B shall be used with a spectrum analyser attached to the test antenna.

The test procedure is as described under clause 5.4.7.2.1.

5.4.7.2.3 Test fixture measurement

The use of a test fixture is not allowed for testing receiver spurious emissions.

5.4.8 Channel access mechanism

5.4.8.1 Test conditions

These measurements shall only be performed at normal test conditions (see clause 5.1.2).

The device shall be configured to operate at its maximum output power level.

5.4.8.2 Test method for FBE

5.4.8.2.1 Additional test conditions

It shall be noted in the test report if the UUT is an initiating device and/or a responding device, see clause 5.4.1, item j).

The FFP(s) implemented by the FBE shall be noted in the test report, see also clause 5.4.1, item j).

All measurements shall have temporal resolution of less than or equal to 1 μ s.

The measurement equipment shall be able to observe the UUT behaviour for a duration of at least 250 ms at the aforementioned temporal resolution. If the data is recorded in segments then the FFPs shall be extracted from each data segment. The combined set of all FFPs shall be analysed as described in clause 5.4.8.2.2.4.

5.4.8.2.2 Conducted measurements

5.4.8.2.2.1 Initialization of the test

Figure 8 shows an example of the test set up.

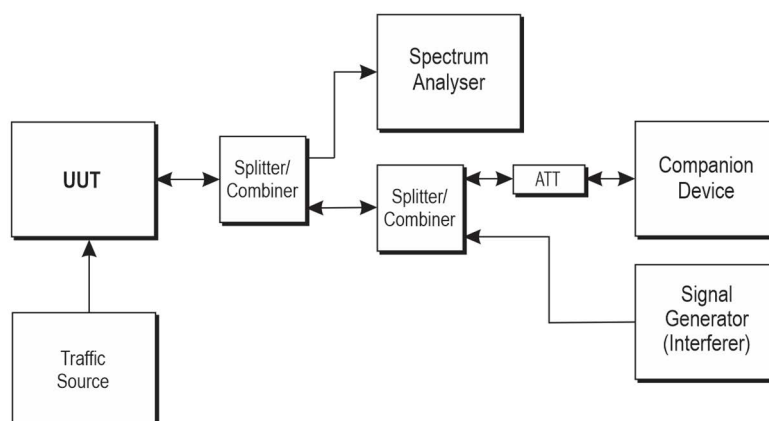

Figure 8: Example test set up for verifying the channel access mechanism of FBE

The different steps below define the procedure to verify the conformance of the channel access mechanism of the equipment.

Step 1:

- The UUT shall connect to a companion device during the test. The signal generator, the spectrum analyser, the UUT, the traffic source and the companion device are connected using a set up equivalent to the example given by figure 8 although the interference source is switched off at this point in time. The spectrum analyser is used to monitor the transmissions of the UUT in response to the interference signal. The traffic source might be part of the UUT itself.
- The received signal level (wanted signal from the companion device) at the UUT shall be sufficient to maintain a reliable link for the duration of the test. A typical value for the received signal level which can be used in most cases is -50 dBm/MHz.
- The spectrum analyser shall be set as follows:
 - RBW: \geq nominal bandwidth (if the analyser does not support this setting, the highest available setting shall be used)
 - VBW: \geq RBW (if the analyser does not support this setting, the highest available setting shall be used)
 - Detector mode: RMS
 - Centre frequency: Centre frequency of the channel being investigated
 - Frequency span: 0 Hz
 - Sweep time: $> 2 \times \text{COT}$
 - Trace mode: Clear/Write
 - Trigger mode: Video or RF/IF Power

Step 2:

- Configure the traffic source so that it fills the UUT's buffers to a level causing the UUT to always have transmissions queued (buffer-ready-for-transmission condition) towards the companion device. Where this is not possible, the UUT shall be configured to occupy the COT of the FFP to the highest extent possible.

To avoid adverse effects on the measurement results, a unidirectional traffic source should be used. An example of such a unidirectional traffic source not triggering reverse traffic on higher layer protocols is UDP.

5.4.8.2.2.2 Procedure to verify the capability to detect other transmissions when operating on a single channel

Step 1: Setting up the communications link

- The UUT shall be configured to operate on a single channel.

Step 2: Adding the interference signal

- One of the three interference signals as defined in clause B.7 is injected on the current channel of the UUT. The bandwidth of this signal shall be such that it covers the current channel. The level of this interference signal at the antenna connector(s) of the UUT shall be equal to the applicable EDT defined in clause 4.3.6.3.1.4 and clause 4.3.6.3.3.

Step 3: Verification of reaction to the interference signal

- The spectrum analyser shall be used to monitor the transmissions of the UUT on the selected channel after the interference signal was injected. This may require the spectrum analyser sweep to be triggered by the start of the interfering signal.
- Using the procedure defined in clause 5.4.8.2.3, it shall be verified that:
 - i) The UUT does not have transmissions on the current channel during the FFP following the first CCA after the interference signal was injected. The UUT is allowed to have SCS transmissions on the current channel, see ii) and iii).

- ii) Apart from SCS transmissions there are no subsequent transmissions while the interfering signal is present.
- iii) The SCS transmissions conform to the limits defined in clause 4.3.6.3.4.

The verification of the SCS transmissions may require the analyser settings to be changed (e.g. sweep time).

- To verify that the UUT is not resuming normal transmissions as long as the interference signal is present, the monitoring time may need to be 60 s or more, in which case a segmented measurement may need to be performed in order to achieve the required resolution.
- Once the test is completed and the interference signal is removed, the UUT may start transmissions again on this channel; however, this is not a requirement and therefore does not require testing.

Step 4:

- Step 2 and step 3 shall be repeated for each of the interference signals defined in clause B.7.

5.4.8.2.2.3 Procedure to verify the capability to detect other transmissions in case of multi-channel operation

Step 1: Setting up the communications link

- The UUT shall be configured to operate on a set of at least two and at most on six adjacent channels. The number of channels used for the multi-channel operation during this test shall be noted in the test report, see clause 5.4.1, item c).
- It shall be verified that the UUT started transmissions on all these channels.

Step 2: Adding the interference signal

- One of the three interference signals as defined in clause B.7 is switched on.
- The centre frequency and the bandwidth of this signal shall be such that it covers all channels used for the multi-channel operation during this test. Alternatively, this test may be performed sequentially by which each of the channels is tested separately using an interference signal that only covers a single channel.
- The level of this interference signal at the antenna connector(s) of the UUT shall be equal to the applicable EDT defined in clause 4.3.6.3.1.4 and clause 4.3.6.3.3.

Step 3: Verification of reaction to the interference signal

- The spectrum analyser shall be used to monitor the transmissions of the UUT after the interference signal was injected. This may require the spectrum analyser sweep to be triggered by the start of the interfering signal.
- Using the procedure defined in clause 5.4.8.2.3, it shall be verified that:
 - i) The UUT does not have transmissions on any of the channels configured in step 1 and on which the interference signal was inserted during the FFP following the first CCA after the interference signal was detected. The UUT is allowed to have SCS transmissions on any of the current channels, see ii) and iii).
 - ii) Apart from SCS transmissions there are no subsequent transmissions of the UUT on any of the channels configured in step 1 and on which the interference signal was inserted, while the interfering signal is present in those channels.
 - iii) The SCS transmissions conform to the limits defined in clause 4.3.6.3.4.

The verification of the SCS transmissions may require the analyser settings to be changed (e.g. sweep time).

- To verify that the UUT is not resuming normal transmissions on any of the channels configured in step 1 as long as the interference signal is present, the monitoring time may need to be 60 s or more, in which case a segmented measurement may need to be performed in order to achieve the required resolution.

- Once the test is completed and the interference signal is removed, the UUT may start transmissions again on any of the channels used for the multi-channel operation configured in step 1; however, this is not a requirement and therefore does not require testing.

Step 4:

- Step 2 and step 3 shall be repeated for each of the interference signals defined in clause B.7.

5.4.8.2.2.4 Procedure to verify the channel access mechanism

The below steps define the test procedure to verify the COT and idle period as part of the channel access mechanism.

Step 1:

- See clause 5.4.8.2.2.1, step 1.

Step 2:

- See clause 5.4.8.2.2.1, step 2.

Step 3: Recording transmissions

- Record start time and duration of every transmission on the channel and record start time and duration of every gap in between transmissions on the channel.
- Let t_x denote a point in time the channel becomes occupied and let d_x denote the duration the channel is subsequently occupied. Let i_y denote a point in time the channel becomes unoccupied and let g_y denote the duration the channel is subsequently unoccupied. Figure 9 presents an example.

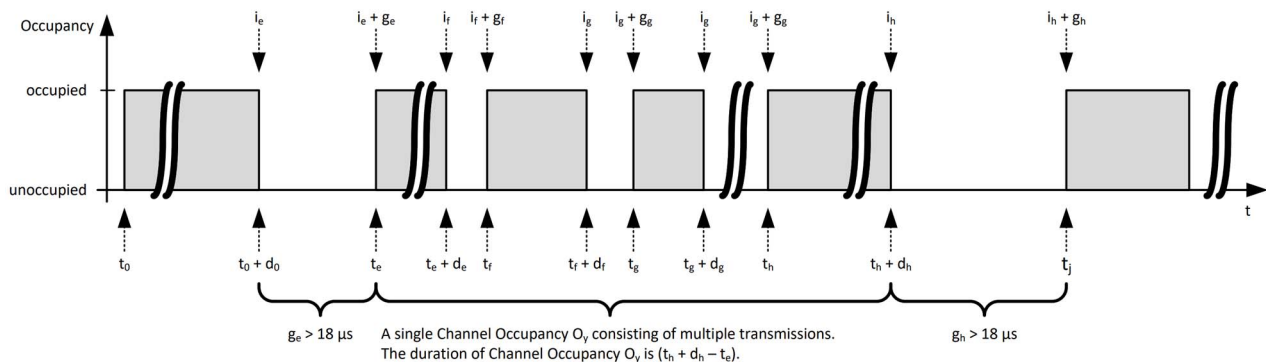

Figure 9: Example of UUT transmissions

Step 4: Measurement of unoccupied periods and Channel Occupancy Times

- Any COT O_x is defined as $(t_h + d_h - t_e)$ with $t_e < t_h$, if within the interval $[t_e, t_h + d_h]$ all periods g_y that the channel is unoccupied have duration of less than or equal to $18 \mu\text{s}$. As defined in clause 4.3.6.3.1.4, any COT may consist of one or more transmissions of the UUT. If the companion device acts as a responding device (see clause 4.3.6.3.1.5), any COT may consist of one or more transmissions of the UUT and zero or more transmissions of the companion device.
- Using the values recorded in step 3, the duration of any of the COTs shall be determined and the duration of any of the unoccupied periods between such COTs shall be determined. An unoccupied period is defined as any period g_y in between transmissions that has a duration greater than $18 \mu\text{s}$. All other gaps in between transmissions are considered as part of the COT.
- Where the source of a COT can be identified as being from the companion device only COT from the UUT need to be assessed for COT conformance.

Step 5: Identification of the FFP

- Based on the measurement results of step 4 and the FFP(s) of the UUT, identify the start point and duration of each FFP.

- The contiguous unoccupied period immediately before the start of a FFP is classified as idle period that belongs to the preceding FFP as defined in clause 4.3.6.3.1.4.

Step 6: Verification of requirements

- Using the results of step 5 it shall be verified that the UUT conforms to the maximum COT and the minimum idle period for each of the FFPs implemented and as defined in clause 4.3.6.3.1.4.

5.4.8.2.3 Generic test procedure for measuring channel/frequency usage

This is a generic test method to evaluate transmissions on the channel being investigated. This test is only performed as part of the procedure described in clause 5.4.8.2.2.2 and clause 5.4.8.2.2.3.

The test procedure shall be as follows:

Step 1:

- The spectrum analyser shall be set as follows:
 - Centre frequency: Centre frequency of the channel being investigated
 - Frequency span: 0 Hz
 - RBW: Approximately 50 % of the nominal bandwidth (if the analyser does not support this setting, the highest available setting shall be used)
 - VBW: \geq RBW (if the analyser does not support this setting, the highest available setting shall be used)
 - Detector mode: RMS
 - Sweep time: $> 2 \times$ COT
 - Sweep points: At least one sweep point per μ s
 - Trace mode: Clear/Write
 - Trigger mode: Video or RF/IF Power

Step 2:

- Save the trace data to a file for further analysis by a computing device using an appropriate software application or program.

Step 3:

- Identify the data points related to the channel being investigated by applying a threshold.
- Count the number of consecutive data points identified as resulting from a single transmission on the channel being investigated and multiply this number by the time difference between two consecutive data points. Repeat this for all the transmissions within the measurement window.
- For measuring idle or silent periods, count the number of consecutive data points identified as resulting from a single transmitter off period on the channel being investigated and multiply this number by the time difference between two consecutive data points. Repeat this for all the transmitter off periods within the measurement window.

5.4.8.2.4 Radiated measurements

The output power of the signal generator simulating the interference signal shall provide a signal power such that the level at the interface between the UUT and its antenna assembly corresponds to the applicable EDT defined in clause 4.3.6.3.1.4 and clause 4.3.6.3.3.

When performing radiated testing on a UUT with a directional antenna (including smart antenna systems and systems capable of beamforming), the wanted communications link (between the UUT and the companion device) and the interference test signals shall be aligned to the direction corresponding to the UUT's maximum antenna gain.

The test set up as described in annex B and applicable measurement procedures as described in annex C shall be used to test the channel access mechanism of the UUT. The test procedure is further as described under clause 5.4.8.2.2.

5.4.8.2.5 Test fixture measurement

The test set up and the normalization procedure as described in clause B.4.4 shall be used with the measuring devices attached to the fixture.

The test procedure is further as described under clause 5.4.8.2.2.

5.4.8.3 Test method for LBE

5.4.8.3.1 Additional test conditions

A UUT that can operate as a supervising device and as a supervised device (see clause 4.3.6.3.2.2) shall be tested for both functionalities.

It shall be noted in the test report if the UUT supports use of note 1 in table 7 or note 1 in table 8, see clause 5.4.1, item k).

If the UUT is a supervising device it shall be noted in the test report if the UUT supports use of note 2 in table 7 in clause 4.3.6.3.2.4, see clause 5.4.1, item k).

It shall be noted in the test report if the UUT is an initiating device and/or a responding device, see clause 5.4.1, item k).

The UUT's theoretical maximum radio performance shall be noted in the test report, see clause 5.4.1, item m).

All priority classes the UUT implements shall be noted in the test report, see clause 5.4.1, item k).

All measurements shall have temporal resolution of less than or equal to 1 μ s.

The measurement equipment shall be able to observe UUT behaviour of at least 10 000 COTs at the aforementioned temporal resolution. This data may be recorded in segments. In that case, the COTs shall be extracted from each data segment. The combined set of all COTs shall be analysed as described in clause 5.4.8.3.2.4.

The priority class used for testing is selected as follows:

- If the UUT implements priority class 2 (and potentially other priority classes), the UUT shall be tested against the requirements of priority class 2 as outlined in table 7 or table 8 in clause 4.3.6.3.2.4.
- If the UUT does not implement priority class 2 but the UUT implements priority class 1 (and potentially other priority classes), the UUT shall be tested against the requirements of priority class 1 as outlined in table 7 or table 8 in clause 4.3.6.3.2.4.
- If the UUT implements neither priority class 2 nor priority class 1 but the UUT implements priority class 3 (and optionally priority class 4), the UUT shall be tested against the requirements of priority class 3 as outlined in table 7 or table 8 in clause 4.3.6.3.2.4.
- If the UUT implements no priority classes other than priority class 4, the UUT shall be tested against the requirements of priority class 4 as outlined in table 7 or table 8 in clause 4.3.6.3.2.4.

5.4.8.3.2 Conducted measurements

5.4.8.3.2.1 Initialization of the test

Figure 10 shows an example of the test set up.

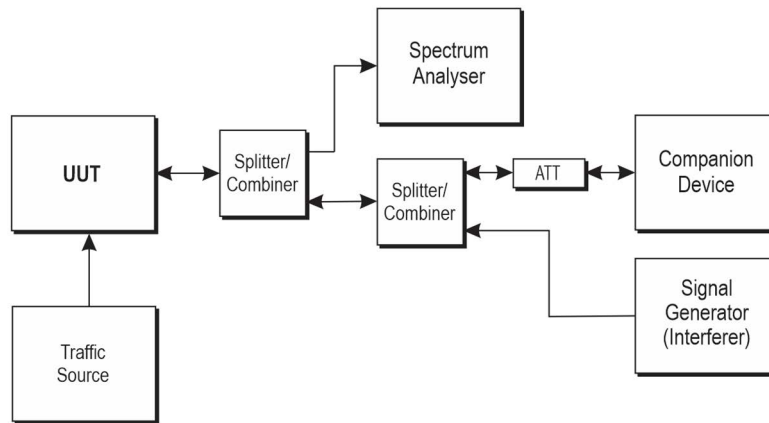

Figure 10: Example test set up for verifying the channel access mechanism of LBE

The different steps below define the procedure to verify the conformance of the channel access mechanism of the equipment.

Step 1:

- The UUT shall connect to a companion device during the test. The signal generator, the spectrum analyser, the UUT, the traffic source and the companion device are connected using a set up equivalent to the example given by figure 10 although the interference source is switched off at this point in time. The spectrum analyser is used to monitor the transmissions of the UUT in response to the interference signal. The traffic source might be part of the UUT itself.
- The received signal level (wanted signal from the companion device) at the UUT shall be sufficient to maintain a reliable link for the duration of the test. A typical value for the received signal level which can be used in most cases is -50 dBm/MHz.
- The spectrum analyser shall be set as follows:
 - RBW: \geq nominal bandwidth (if the analyser does not support this setting, the highest available setting shall be used)
 - VBW: $3 \times$ RBW (if the analyser does not support this setting, the highest available setting shall be used)
 - Detector mode: RMS
 - Centre frequency: Centre frequency of the channel being investigated
 - Frequency span: 0 Hz
 - Sweep time: $> 2 \times$ COT
 - Trace mode: Clear/Write
 - Trigger mode: Video or RF/IF power

Step 2:

- Configure the traffic source so that it exceeds the UUT's theoretical radio performance. The traffic source shall fill the UUT's buffers causing the UUT to always have transmissions queued (full buffer condition) towards the companion device. To avoid adverse effects on the measurement results, a unidirectional traffic source should be used. An example of such a unidirectional traffic source not triggering reverse traffic on higher layer protocols is UDP.

5.4.8.3.2.2 Procedure to verify the capability to detect other transmissions when operating on a single channel

Step 1: Setting up the communications link

- The UUT shall be configured to operate on a single channel.

Step 2: Adding the interference signal

- One of the three interference signals as defined in clause B.7 is injected on the current channel of the UUT. The bandwidth of this signal shall be such that it covers the current channel. The level of this interference signal at the antenna connector(s) of the UUT shall be equal to the applicable EDT defined in clause 4.3.6.3.3.

Step 3: Verification of reaction to the interference signal

- The spectrum analyser shall be used to monitor the transmissions of the UUT on the selected channel after the interference signal was injected. This may require the spectrum analyser sweep to be triggered by the start of the interfering signal.
- Using the procedure defined in clause 5.4.8.3.3, it shall be verified that:
 - i) The UUT stops transmissions on the current channel.
The UUT is expected to stop transmissions within a period equal to the maximum COT that corresponds to the priority class being tested (see table 7 and table 8). The UUT is allowed to have SCS transmissions on the current channel, see ii) and iii).
 - ii) Apart from SCS transmissions there are no subsequent transmissions while the interfering signal is present.
 - iii) The SCS transmissions shall conform to the limits defined in clause 4.3.6.3.4.3.
The verification of the SCS transmissions may require the analyser settings to be changed (e.g. sweep time).
- To verify that the UUT is not resuming normal transmissions as long as the interference signal is present, the monitoring time may need to be 60 s or more, in which case a segmented measurement may need to be performed in order to achieve the required resolution.
- Once the test is completed and the interference signal is removed, the UUT may start transmissions again on this channel however this is not a requirement and therefore does not require testing.

Step 4:

- Step 2 and step 3 shall be repeated for each of the interference signals defined in clause B.7.

5.4.8.3.2.3 Procedure to verify the capability to detect other transmissions in case of multi-channel operation

5.4.8.3.2.3.1 Equipment implementing option 1 for multi-channel operation

Step 1: Setting up the communications link

- The UUT shall be configured to operate on a set of at least two and at most on six adjacent channels. The number of channels used for the multi-channel operation during this test shall be noted in the test report, see clause 5.4.1, item c).

It shall be verified that the UUT started transmissions on all these channels.

Step 2: Adding the interference signal

- One of the three interference signals as defined in clause B.7 is switched on.

- The centre frequency and the bandwidth of this signal shall be such that it covers all channels used for the multi-channel operation during this test. Alternatively, this test may be performed sequentially by which each of the channels is tested separately using an interference signal that only covers a single channel.
- The level of this interference signal at the antenna connector(s) of the UUT shall be equal to the applicable EDT defined in clause 4.3.6.3.3.

Step 3: Verification of reaction to the interference signal

- The spectrum analyser shall be used to monitor the transmissions of the UUT after the interference signal was injected. This may require the spectrum analyser sweep to be triggered by the start of the interfering signal.
- Using the procedure defined in clause 5.4.8.3.3, it shall be verified that:
 - i) The UUT stops transmissions on any of the channels configured in step 1 and on which the interference signal was inserted.

The UUT is expected to stop transmissions on any of the channels used for the multi-channel operation (see step 1) during this test, and on which the interference signal was inserted, within a period equal to the maximum COT that corresponds to the priority class being tested (see table 7 and table 8). The UUT is allowed to have SCS transmissions on any of the channels configured in step 1, see also ii) and iii) below.
 - ii) Apart from SCS transmissions there are no subsequent transmissions of the UUT on the channels while the interfering signal is present in those channels.
 - iii) The SCS transmissions shall conform to the limits defined in clause 4.3.6.3.4.3.

The verification of the SCS transmissions may require the analyser settings to be changed (e.g. sweep time).
- To verify that the UUT is not resuming normal transmissions in a channel as long as the interference signal is present in that channel, the monitoring time may need to be 60 s or more, in which case a segmented measurement may need to be performed in order to achieve the required resolution.
- Once the test is completed and the interference signal is removed, the UUT may start transmissions again on any of the channels used for the multi-channel operation configured in step 1; however, this is not a requirement and, therefore, does not require testing.

Step 4:

- Step 2 and step 3 shall be repeated for each of the interference signals defined in clause B.7.

5.4.8.3.2.3.2 Equipment implementing option 2 for multi-channel operation

Step 1: Setting up the communications link

- The UUT shall be configured to operate on a group of adjacent channels with a total bandwidth of 40 MHz. One of the two adjacent channels within this group is configured as the primary channel (see clause 4.3.6.3.2.3, option 2).
- It shall be verified that the UUT started transmissions within the 40 MHz group of adjacent channels.

Step 2: Adding the interference signal

- The interference signal as defined in clause B.7.1 is switched on.
- The centre frequency and the bandwidth of the interference signal shall be as such that it covers only the adjacent (non-primary) channel, it shall not cover the primary channel. See clause B.7.
- The level of this interference signal at the antenna connector(s) of the UUT shall be equal to the applicable EDT defined in clause 4.3.6.3.3.

Step 3: Verification of reaction to the interference signal

- The spectrum analyser shall be used to monitor the transmissions of the UUT after the interference signal was injected. This may require the spectrum analyser sweep to be triggered by the start of the interfering signal.
- Using the procedure defined in clause 5.4.8.3.3, it shall be verified that:
 - i) The UUT stops transmissions on the adjacent (non-primary) channel.
 The UUT is expected to stop transmissions on the adjacent (non-primary) channel within a period equal to the maximum COT that corresponds to the priority class being tested (see table 7 and table 8). The UUT is allowed to have SCS transmissions on the adjacent (non-primary) channel, see ii) and iii).
 - ii) Apart from SCS transmissions there shall be no subsequent transmissions on the adjacent (non-primary) channel while the interfering signal is present.
 - iii) The SCS transmissions shall conform to the limits defined in clause 4.3.6.3.4.
 The verification of the SCS transmissions may require the analyser settings to be changed (e.g. sweep time).
- To verify that the UUT is not resuming normal transmissions on the adjacent (non-primary) channel as long as the interference signal is present, the monitoring time may need to be 60 s or more, in which case a segmented measurement may need to be performed in order to achieve the required resolution.
- Once the test is completed and the interference signal is removed, the UUT may start transmissions again on the adjacent (non-primary) channel. However, this is not a requirement and, therefore, does not require testing.

5.4.8.3.2.4 Procedure to verify the channel access mechanism

The below steps define the test procedure to verify the channel access mechanism implemented by the UUT.

Step 1:

- See clause 5.4.8.3.2.1, step 1.

Step 2:

- See clause 5.4.8.3.2.1, step 2.
- If the UUT is making use of note 1 in table 7 in clause 4.3.6.3.2.4, the following additionally applies:
 - Configure a second traffic source so that it exceeds the companion device's theoretical radio performance. The second traffic source shall fill the companion device's buffers causing the companion device to always have transmissions queued (full buffer condition) towards the UUT.
 - In this test, the supervising device shall issue one or more grants with each COT. Per COT one and not more than one grant shall foresee inserting a single pause of at least 100 μ s, see clause 4.3.6.3.2.4, table 7, note 1.

Step 3: Recording transmissions

- Record start time and duration of every transmission (energy) on the channel and record start time and duration of every idle period on the channel.
- Let t_x denote a point in time the channel becomes occupied and let d_x denote the duration the channel is subsequently occupied. Let i_y denote a point in time the channel becomes unoccupied and let g_y denote the duration the channel is subsequently unoccupied. Figure 11 presents an example.

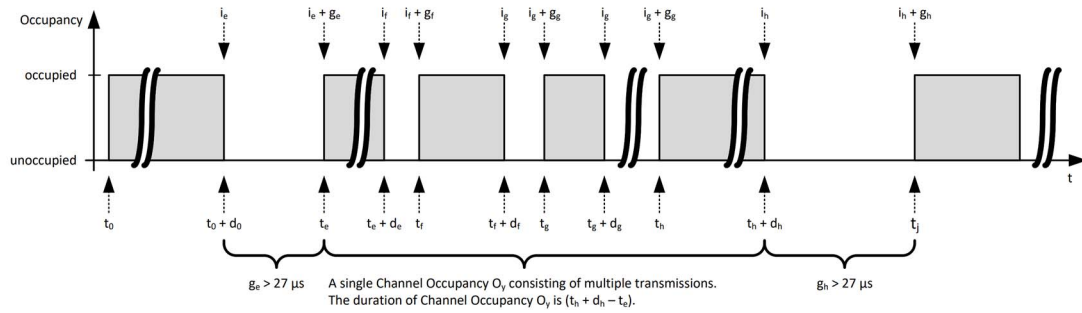

Figure 11: Example of UUT transmissions

Step 4: Measurement of idle periods and COTs

- Any COT O_x is defined as $(t_h + d_h - t_e)$ with $t_e < t_h$, if within the interval $[t_e, t_h + d_h]$ all periods g_y that the channel is unoccupied have duration of less than or equal to $27 \mu\text{s}$. As defined in clause 4.3.6.3.2.2, any COT may consist of one or more transmissions of the UUT and zero or more transmissions of the companion device.
- Using the values recorded in step 3, the duration of any of the COTs shall be determined and the duration of any of the idle periods between such COTs shall be determined. An idle period is defined as any period g_y that has a duration greater than $27 \mu\text{s}$.
- Where the source of a COT can be identified as being from the companion device only COT from the UUT need to be assessed for COT conformance.

Step 5: Classification of idle periods

- k shall be an integer greater than or equal to zero.
- Assign all idle periods to one of $k + 1$ different bins. The value of k depends on the priority class used for the test. A bin is denoted as B_n with $0 \leq n \leq k$:
 - If the priority class used for the test is 1, then $k = 16$ and the bins are denoted $B_0 \dots B_{16}$.
 - If the priority class used for the test is 2, the following applies:
 - If the UUT makes use of note 2 in table 7 in clause 4.3.6.3.2.4, then $k = 32$ and the bins are denoted $B_0 \dots B_{32}$.
 - If the UUT does not make use of note 2 in table 7 in clause 4.3.6.3.2.4, then $k = 16$ and the bins are denoted $B_0 \dots B_{16}$.
 - If the priority class used for the test is 3, then $k = 8$ and the bins are denoted $B_0 \dots B_8$.
 - If the priority class used for the test is 4, then $k = 4$ and the bins are denoted $B_0 \dots B_4$.
- If the priority class used for the test is 1, bin B_n is defined as:

$$B_n = \begin{cases} [0, 77[\mu\text{s}, & n = 0 \\ [77 + 9 \times (n-1), 77 + 9 \times n[\mu\text{s}, & 1 \leq n \leq 15 \\ [212, \infty[\mu\text{s}, & n = 16 \end{cases}$$
- If the priority class used for the test is 2, bin B_n is defined as below:
 - If the UUT is a supervising device making use of note 2 in table 7 in clause 4.3.6.3.2.4, bin B_n is defined as:

$$B_n = \begin{cases} [0, 41[\mu\text{s}, & n = 0 \\ [41 + 9 \times (n-1), 41 + 9 \times n[\mu\text{s}, & 1 \leq n \leq 31 \\ [320, \infty[\mu\text{s}, & n = 32 \end{cases}$$

- If the UUT is a supervised device or if the UUT is a supervising device not making use of note 2 in table 7 in clause 4.3.6.3.2.4, bin B_n is defined as:

$$B_n = \begin{cases} [0, 41[\mu\text{s}, & n = 0 \\ [41 + 9 \times (n-1), 41 + 9 \times n[\mu\text{s}, & 1 \leq n \leq 15 \\ [176, \infty[\mu\text{s}, & n = 16 \end{cases}$$

- If the priority class used for the test is 3, bin B_n is defined as below:

- If the UUT is a supervised device, bin B_n is defined as:

$$B_n = \begin{cases} [0, 32[\mu\text{s}, & n = 0 \\ [32 + 9 \times (n-1), 32 + 9 \times n[\mu\text{s}, & 1 \leq n \leq 7 \\ [95, \infty[\mu\text{s}, & n = 8 \end{cases}$$

- If the UUT is a supervising device, bin B_n is defined as:

$$B_n = \begin{cases} [0, 23[\mu\text{s}, & n = 0 \\ [23 + 9 \times (n-1), 23 + 9 \times n[\mu\text{s}, & 1 \leq n \leq 7 \\ [86, \infty[\mu\text{s}, & n = 8 \end{cases}$$

- If the priority class used for the test is 4, bin B_n is defined as below:

- If the UUT is a supervised device, bin B_n is defined as:

$$B_n = \begin{cases} [0, 32[\mu\text{s}, & n = 0 \\ [32 + 9 \times (n-1), 32 + 9 \times n[\mu\text{s}, & 1 \leq n \leq 3 \\ [59, \infty[\mu\text{s}, & n = 4 \end{cases}$$

- If the UUT is a supervising device, bin B_n is defined as:

$$B_n = \begin{cases} [0, 23[\mu\text{s}, & n = 0 \\ [23 + 9 \times (n-1), 23 + 9 \times n[\mu\text{s}, & 1 \leq n \leq 3 \\ [50, \infty[\mu\text{s}, & n = 4 \end{cases}$$

Step 6: Idle period probability evaluation

- Let $H(B_n)$ define the number of idle periods assigned to bin B_n .
- Let E define the total number of idle periods observed. Then E is the sum of events in all bins:

$$E = \sum_{n=0}^k H(B_n)$$

Calculate the observed cumulative probabilities as follows:

- Let $p(n)$ define the probability that idle periods of duration less than the upper limit specified for bin B_n occurred, $p(n) = p(\text{idle period} < \text{upper limit of bin } B_n)$.
- Then, for each n , $0 \leq n \leq k$, calculate $p(n)$ as:

$$p(n) = \frac{\sum_{i=0}^n H(B_i)}{E}$$

The following test methodology shall be used to verify that the UUT's channel access mechanism complies with the limits defined in table 7 and table 8, see clause 4.3.6.3.2.4.

If the priority class used for the test is 1, each cumulative probability $p(n)$ of all idle periods recorded in bins $[B_0 \dots B_n]$ shall not exceed the following maximum probability:

$$p(n) \leq \begin{cases} 0,05, & n = 0 \\ 0,12, & n = 1 \\ 0,12 + (n-1) \times 0,0625, & 2 \leq n \leq 15 \\ 1, & n > 15 \end{cases}$$

If the priority class used for the test is 2, each cumulative probability $p(n)$ of all idle periods recorded in bins $[B_0 \dots B_n]$ shall not exceed the following maximum probability.

If the UUT makes use of note 2 in table 7 in clause 4.3.6.3.2.4:

$$p(n) \leq \begin{cases} 0,05, & n = 0 \\ 0,12, & n = 1 \\ 0,12 + (n-1) \times 0,03125, & 2 \leq n \leq 29 \\ 1, & n > 29 \end{cases}$$

If the UUT does not make use of note 2 in table 7 in clause 4.3.6.3.2.4:

$$p(n) \leq \begin{cases} 0,05, & n = 0 \\ 0,12, & n = 1 \\ 0,12 + (n-1) \times 0,0625, & 2 \leq n \leq 15 \\ 1, & n > 15 \end{cases}$$

If the UUT makes use of note 1 in table 7 in clause 4.3.6.3.2.4:

$$p(n) \leq \begin{cases} 0,05, & n = 0 \\ 0,09 + (n-1) \times 0,03125, & 1 \leq n \leq 7 \\ 0,59 + (n-1) \times 0,03125, & 8 \leq n \leq 14 \\ 1, & n > 14 \end{cases}$$

If the priority class used for the test is 3, each cumulative probability $p(n)$ of all idle periods recorded in bins $[B_0 \dots B_n]$ shall not exceed the following maximum probability:

$$p(n) \leq \begin{cases} 0,05, & n = 0 \\ 0,18, & n = 1 \\ 0,18 + (n-1) \times 0,125, & 2 \leq n \leq 6 \\ 1, & n > 6 \end{cases}$$

If the priority class used for the test is 4, each cumulative probability $p(n)$ of all idle periods recorded in bins $[B_0 \dots B_n]$ shall not exceed the following maximum probability:

$$p(n) \leq \begin{cases} 0,05, & n = 0 \\ 0,05 + n \times 0,25, & 1 \leq n \leq 3 \\ 1, & n > 3 \end{cases}$$

5.4.8.3.2.5 Procedure to verify the maximum COT(s)

The below steps define the test procedure to verify the maximum COT(s) implemented by the UUT.

A channel occupancy consists of transmissions from the UUT and may contain transmissions of the companion device. See clause 4.3.6.3.2.2.

The COTs shall be determined using the results of step 4 in clause 5.4.8.3.2.4. These COTs shall be noted in the test report.

The configuration in step 2 of clause 5.4.8.3.2.1 is assumed to result in an operational mode that enables the longest COT for the UUT to occur.

The UUT conforms to the limit for the maximum COT under the following conditions:

- If the priority class used for the test is 1, none of the COTs shall exceed 6 ms.
- If the priority class used for the test is 2, none of the COTs shall exceed the following limits:
 - 6 ms if the UUT makes use of note 1 in table 7 in clause 4.3.6.3.2.4.
 - 10 ms if the UUT makes use of note 2 in table 7 in clause 4.3.6.3.2.4.
 - 6 ms if the UUT does not make use of note 2 in table 7 in clause 4.3.6.3.2.4.
- If the priority class used for the test is 3, none of the COTs shall exceed 4 ms.

- If the priority class used for the test is 4, none of the COTs shall exceed 2 ms.

5.4.8.3.3 Generic test procedure for measuring channel/frequency usage

This is a generic test method to evaluate transmissions on the channel being investigated. This test is only performed as part of the procedure described in clause 5.4.8.3.2.2, clause 5.4.8.3.2.3.1 and clause 5.4.8.3.2.3.2.

The test procedure shall be as follows:

Step 1:

- The spectrum analyser shall be set as follows:
 - Centre frequency: Centre frequency of the channel being investigated
 - Frequency span: 0 Hz
 - RBW: Approximately 50 % of the nominal bandwidth (if the analyser does not support this setting, the highest available setting shall be used)
 - VBW: \geq RBW (if the analyser does not support this setting, the highest available setting shall be used)
 - Detector mode: RMS
 - Sweep time: $> 2 \times$ COT
 - Sweep points: At least one sweep point per μ s
 - Trace mode: Clear/Write
 - Trigger mode: Video or RF/IF power

Step 2:

- Save the trace data to a file for further analysis by a computing device using an appropriate software application or program.

Step 3:

- Identify the data points related to the channel being investigated by applying a threshold.
- Count the number of consecutive data points identified as resulting from a single transmission on the channel being investigated and multiply this number by the time difference between two consecutive data points. Repeat this for all the transmissions within the measurement window.
- For measuring idle or silent periods, count the number of consecutive data points identified as resulting from a single transmitter off period on the channel being investigated and multiply this number by the time difference between two consecutive data points. Repeat this for all the transmitter off periods within the measurement window.

5.4.8.3.4 Radiated measurements

The output power of the signal generator simulating the interference signal shall provide a signal power such that the level at the interface between the UUT and its antenna assembly corresponds to the applicable EDT defined in clause 4.3.6.3.3.

When performing radiated testing on a UUT with a directional antenna (including smart antenna systems and systems capable of beamforming) the wanted communications link (between the UUT and the companion device) and the interference test signals shall be aligned to the direction corresponding to the UUT's maximum antenna gain.

The test set up as described in annex B and applicable measurement procedures as described in annex C shall be used to test the channel access mechanism of the UUT. The test procedure is further as described under clause 5.4.8.3.2.

5.4.8.3.5 Test fixture measurement

The test set up and the normalization procedure as described in clause B.4.4 shall be used with the spectrum analyser attached to the fixture.

The test procedure is further as described under clause 5.4.8.3.2.

5.4.9 Receiver blocking

5.4.9.1 Test conditions

These measurements shall only be performed at normal test conditions (see clause 5.1.2).

The UUT shall operate in its normal operational mode.

For devices which can change their channel frequency automatically (e.g. adaptive channel allocation), this function shall be disabled.

For VLP NB equipment, the measurements may be performed on a single frequency or during normal operation (potentially using multiple hop frequencies).

If the equipment can be configured to operate with different nominal bandwidths and different data rates, then the combination of the smallest channel bandwidth and the lowest data rate for this channel bandwidth which still allows the equipment to operate as intended shall be used. This mode of operation shall be aligned with the performance criteria defined in clause 4.3.7.2 and shall be described in the test report.

It shall be verified that this performance criteria is achieved during the blocking test.

5.4.9.2 Test methods

5.4.9.2.1 Conducted measurement

For systems using multiple receive chains only one chain needs to be tested. All other receiver inputs shall be terminated.

Figure 12 shows the test set up which can be used for performing the receiver blocking test. The companion device may require appropriate shielding or may need to be put in a shielded room to prevent a negative impact on the measurement.

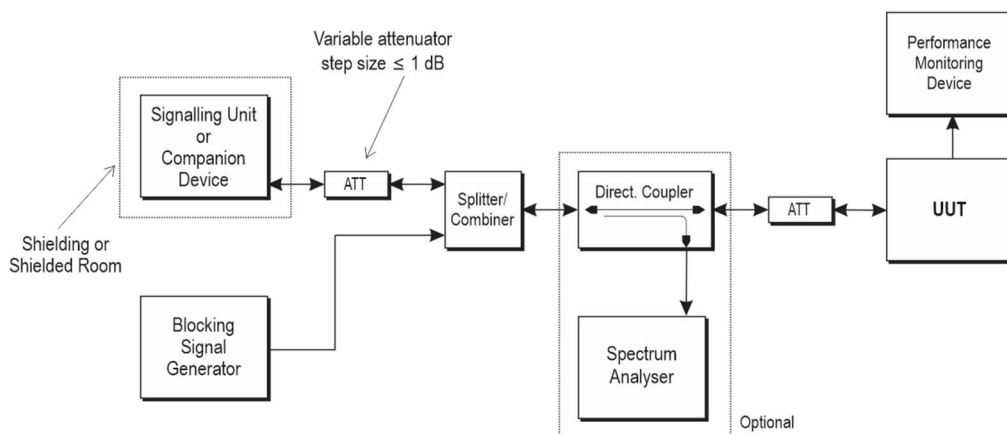

Figure 12: Test set up for receiver blocking

The steps below define the procedure to verify the receiver blocking requirement as described in clause 4.3.7.

Step 1:

- The UUT shall be set to the first channel or VLP NB transmission to be investigated.

Step 2:

- The blocking signal generator is set to the first frequency for the equipment type as defined in either table 9 or table 10.

Step 3:

- With the blocking signal generator switched off a communication link is set up between the UUT and the associated companion device using the test setup shown in figure 12. The attenuation of the variable attenuator shall be increased in 1 dB steps to a value at which the minimum performance criteria as specified in clause 4.3.7.2 is still met. The resulting level for the wanted signal at the input of the UUT is P_{\min} .
- This signal level (P_{\min}) is increased by 6 dB resulting in a new level ($P_{\min} + 6$ dB) of the wanted signal at the UUT receiver input.

Step 4:

- The level of the blocking signal at the UUT input is set to the level provided in the table selected in step 2. It shall be verified and recorded in the test report that the performance criteria as specified in clause 4.3.7.2 is met.
- If the performance criteria as specified in clause 4.3.7.2 are met, the level of the blocking signal at the UUT may be further increased (e.g. in steps of 1 dB) until the level whereby the performance criteria as specified in clause 4.3.7.2 are no longer met. The highest level at which the performance criteria are met is recorded in the test report.

Step 5:

- Repeat step 4 for each remaining combination of frequency and level as specified in the table selected in step 2.

Step 6:

- Repeat step 2 to step 5 with the UUT operating at the other channels or VLP NB transmissions at which the blocking test has to be performed.

5.4.9.2.2 Radiated measurement

When performing radiated measurements on equipment with dedicated antennas, measurements shall be repeated for each alternative dedicated antenna.

A test site as described in annex B and applicable measurement procedures as described in annex C shall be used.

The test procedure is further as described under clause 5.4.9.2.1.

The level of the blocking signal at the UUT referred to in step 4 is assumed to be the level in front of the UUT antenna(s). The UUT shall be configured/positioned with its main beam pointing towards the antenna radiating the blocking signal. The configuration/position recorded in clause 5.4.3.2.2 can be used.

5.4.9.2.3 Test fixture measurement

The test set up and the normalization procedure as described in clause B.4.4 shall be used with the measuring devices attached to the fixture.

The test procedure is further as described under clause 5.4.9.2.1.

5.4.10 Receiver selectivity

5.4.10.1 Test conditions

These measurements shall only be performed at normal test conditions (see clause 5.1.2).

For devices which can change their channel frequency automatically (e.g. adaptive channel allocation), this function shall be disabled.

The UUT shall operate in its normal operational mode, except that it shall be configured to operate within a nominal bandwidth of 20 MHz and at the lowest data rate for this channel bandwidth or VLP NB transmission.

For VLP NB equipment, the measurements may be performed on a single frequency or during normal operation (potentially using multiple hop frequencies).

It shall be verified that the performance criteria as defined in clause 4.3.8.2 are achieved during the receiver selectivity test.

5.4.10.2 Test methods

5.4.10.2.1 Conducted measurement

For systems using multiple receive chains only one chain needs to be tested. All other receiver inputs shall be terminated.

Figure 13 shows the test set up which can be used for performing the receiver selectivity test. The companion device may require appropriate shielding or may need to be put in a shielded room to prevent a negative impact on the measurement.

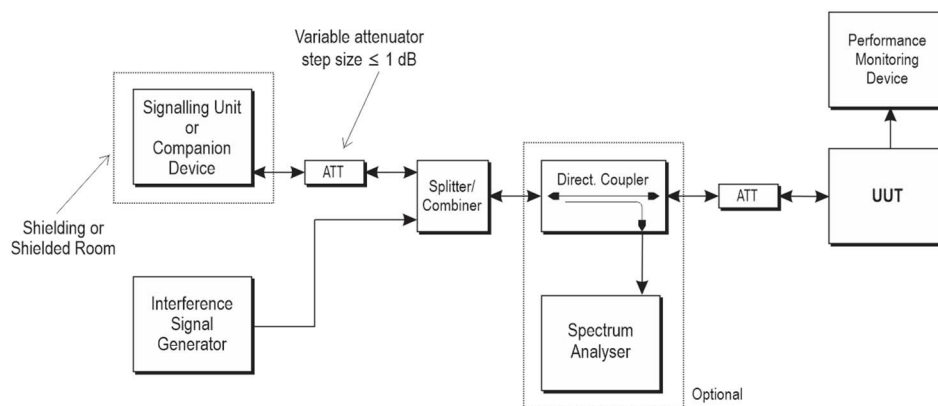

Figure 13: Test set up for receiver selectivity

The steps below define the procedure to verify the receiver selectivity requirement as described in clause 4.3.8.

Step 1:

- The UUT shall be set to the lowest channel or VLP NB transmission to be investigated.

NOTE: All channels tested (lowest and highest) should be within the range 5 985 MHz to 6 385 MHz, see also clause 5.3.2.

Step 2:

- The interference source is set to operate in the upper adjacent channel using the 20 MHz frequency offset and interferer signal power level as defined in table 11.

Step 3:

- With the interference source switched off a communication link is set up between the UUT and the associated companion device using the test setup shown in figure 13. The attenuation of the variable attenuator shall be increased in 1 dB steps to a value at which the minimum performance criteria as specified in clause 4.3.8.2 is still met. The resulting level for the wanted signal at the input of the UUT is P_{\min} .
- This signal level (P_{\min}) is increased by 10 dB resulting in a new level ($P_{\min} + 10$ dB) of the wanted signal at the UUT receiver input.

Step 4:

- The interference signal source which shall transmit continuously unsynchronized with a duty cycle of at least 50 % is switched on. The level of the interference source at the UUT input is set to the level provided in table 11. It shall be verified and recorded in the test report that the performance criteria as specified in clause 4.3.8.2 are met.
- If the performance criteria as specified in clause 4.3.8.2 are met, the level of the interference source at the UUT may be further increased (e.g. in steps of 1 dB) until the level whereby the performance criteria as specified in clause 4.3.8.2 are no longer met. The highest level at which the performance criteria are met is recorded in the test report.

Step 5:

- Repeat step 4 after the interference source is set to operate in the lower adjacent channel using the 20 MHz frequency offset and interferer signal power level as defined in table 11.

Step 6:

- Repeat step 4 after the interference source is set to operate in the upper alternate adjacent channel using the 40 MHz frequency offset and interferer signal power level as defined in table 11.

Step 7:

- Repeat step 4 after the interference source is set to operate in the lower alternate adjacent channel using the 40 MHz frequency offset and interferer signal power level as defined in table 11.

Step 8:

- Repeat step 2 to step 8 for the highest channel frequency to be tested.

5.4.10.2.2 Radiated measurements

When performing radiated measurements on equipment with dedicated antennas, measurements shall be repeated for each alternative dedicated antenna.

A test site as described in annex B and applicable measurement procedures as described in annex C shall be used.

The test procedure is further as described under clause 5.4.10.2.1.

The level of the interference source at the UUT referred to in step 4 is assumed to be the level in front of the UUT antenna(s). The UUT shall be configured/positioned with its main beam pointing towards the antenna radiating the interference source. The configuration/position recorded in clause 5.4.3.2.2 can be used.

5.4.10.2.3 Test fixture measurement

The test set up and the normalization procedure as described in clause B.4.4 shall be used with the measuring devices attached to the fixture.

The test procedure is further as described under clause 5.4.10.2.1.

5.4.11 Mechanical and electrical design

The UUT shall be verified by visual inspection of its mechanical and electrical design requirements depending on the sub-category of the device as stated in clause 4.3.9.

The outcome of this assessment shall be recorded in the test report.

5.4.12 VLP NB operation with a PSD exceeding 1 dBm/MHz

5.4.12.1 Test conditions

This test verifies VLP NB operation with a PSD exceeding 1 dBm/MHz, see clause 5.4.1, item a).

These measurements shall only be performed at normal test conditions (see clause 5.1.2).

The centre frequencies at which the UUT will be transmitting with a PSD exceeding 1 dBm/MHz shall be noted in the test report.

For each centre frequency, the bandwidth(s) of the transmissions with a PSD exceeding 1 dBm/MHz shall be noted in the test report.

The measurement shall be performed according to note 2, table 12.

The UUT shall be configured to operate at its maximum duty cycle during normal operation.

The UUT shall be configured to operate at its maximum output power level.

5.4.12.2 Test methods

5.4.12.2.1 Conducted measurements

5.4.12.2.1.1 Duty cycle

The following steps define the procedure to verify the duty cycle of VLP NB operation with a PSD exceeding 1 dBm/MHz.

Step 1:

The output of the transmitter shall be connected to a spectrum analyser.

The spectrum analyser shall be set as follows:

- RBW: \geq nominal bandwidth (if the analyser does not support this setting, the highest available setting shall be used)
- VBW: $3 \times$ RBW (if the analyser does not support this setting, the highest available setting shall be used)
- Detector mode: RMS
- Centre frequency: Centre frequency of the VLP NB transmission to be investigated
- Frequency span: 0 Hz
- Sweep time: > 2 s
- Trace mode: Clear/Write
- Trigger mode: Video or RF/IF power

Step 2:

For the selected centre frequencies it shall be verified that the total time during which relevant transmissions are present does not exceed 66 ms of any 1 s observation period occurring during the sweep time. Relevant transmissions are present when the PSD exceeds 1 dBm/MHz anywhere within the supported bandwidth for that centre frequency.

Step 3:

The measurements shall be repeated for any supported bandwidths and compared against the limit in clause 4.3.3.3.

5.4.12.2.1.2 Number of hop frequencies

The following steps define the procedure to verify the number of frequency hops of VLP NB operation with a PSD exceeding 1 dBm/MHz.

Step 1:

The output of the transmitter shall be connected to a spectrum analyser.

The spectrum analyser shall be set as follows:

- Start frequency: 5 945 MHz
- Stop frequency: 6 425 MHz

NOTE: The start and stop frequencies may be adjusted to cover only the frequency range over which the NB transmissions occur, see clause 5.4.1, item b).

- RBW: < 50 % of the NB transmission bandwidth (single hop frequency)
- VBW: \geq RBW
- Detector mode: Peak
- Sweep time: Auto

The frequency band may be segmented or the sweep points increased to identify the centre frequencies noted under clause 5.4.1, item b).

- Sweep mode: Continuous
- Trace mode: Max Hold
- Trigger: Free Run

Step 2:

Wait for the trace to stabilize. Identify the number of hop frequencies used by the VLP NB equipment and compare against the limit in clause 4.3.3.3.

5.4.12.2.2 Radiated measurements

A test site as described in annex B and applicable measurement procedures as described in annex C may be used. Alternatively, a test fixture may be used.

The test procedure is further as described under clause 5.4.12.2.1.

5.4.12.2.3 Test fixture measurement

The test set up and the procedure as described in clause B.4 shall be used with the spectrum analyser attached to the test fixture.

The test procedure is further as described under clause 5.4.12.2.1.

5.4.13 Assessment procedure for UAR

5.4.13.1 Introduction

The aim of this assessment procedure is to verify that it is not possible to change the parameters identified in clause 4.3.10.2 by means of any configuration interface available either on the UUT or on an external controller that may be used for networked devices.

5.4.13.2 Test conditions

This assessment shall be performed at normal test conditions (see clause 5.1.2).

The UUT shall operate in its normal operational mode.

For a UUT which requires connection (wired or wireless) to an external device for its configuration, this external device shall be made available to allow the assessment procedure defined in the test method below to be performed. The details of this external device shall be described in the test report.

5.4.13.3 Test Method

The UUT's configuration options shall be inspected on all interfaces that the equipment offers for its configuration. All interfaces in this context includes those provided by any external controller (e.g. hardware-based, cloud-based, or centralized solutions). In these cases, all equipment required to inspect these interfaces shall be included in this assessment.

It shall be verified by visual inspection of all configuration screens whether there are any commands or settings available to the user which would allow the user to (re-)configure the equipment parameters listed in clause 4.3.10.2 so that it is no longer compliant with the requirements of the present document.

The outcome of this assessment shall be recorded in the test report.

Annex A (informative): Relationship between the present document and the essential requirements of Directive 2014/53/EU

The present document has been prepared under the Commission's standardisation request C(2015) 5376 final [i.2] to provide one voluntary means of conforming to the essential requirements of Directive 2014/53/EU on the harmonisation of the laws of the Member States relating to the making available on the market of radio equipment and repealing Directive 1999/5/EC [i.1].

Once the present document is cited in the Official Journal of the European Union under that Directive, compliance with the normative clauses of the present document given in table A.1 confers, within the limits of the scope of the present document, a presumption of conformity with the corresponding essential requirements of that Directive and associated EFTA regulations.

Table A.1: Relationship between the present document and the essential requirements of Directive 2014/53/EU

Harmonised Standard ETSI EN 303 687					
Requirement				Requirement conditionality	
No	Description	Essential requirements of Directive	Clause(s) of the present document	U/C	Condition
1	Nominal centre frequencies/nominal bandwidth	3.2	4.3.1	U	
2	RF output power	3.2	4.3.2	U	
3	PSD	3.2	4.3.3.2	U	
4	VLP NB usage with a PSD above 1 dBm/MHz	3.2	4.3.3.3	C	Where supported by the VLP equipment.
5	Transmitter unwanted emissions outside the 6 GHz WAS/RLAN band	3.2	4.3.4.1, 4.3.4.2	U	
6	Transmitter unwanted emissions within the 6 GHz WAS/RLAN band	3.2	4.3.4.3.2.1	U	
			4.3.4.3.2.2	C	Where multi-channel operation in adjacent channels is supported
			4.3.4.3.2.3	C	Where multi-channel operation in non-adjacent channels is supported
7	Receiver spurious emissions	3.2	4.3.5	U	
8	Channel access mechanism for FBE	3.2	4.3.6.3.1	C	Where devices operate as FBE
9	Channel access mechanism for LBE	3.2	4.3.6.3.2	C	Where devices operate as LBE
10	Receiver blocking	3.2	4.3.7	U	
11	Receiver selectivity	3.2	4.3.8	U	
12	Mechanical and electrical design	3.2	4.3.9	U	
13	User Access Restrictions	3.2	4.3.10	U	

Key to columns:

Requirement:

No A unique identifier for one row of the table which may be used to identify a requirement.

Description A textual reference to the requirement.

Essential requirements of Directive

Identification of article(s) defining the requirement in the Directive.

Clause(s) of the present document

Identification of clause(s) defining the requirement in the present document unless another document is referenced explicitly.

Requirement conditionality:

U/C	Indicates whether the requirement is unconditionally applicable (U) or is conditional upon the manufacturer's claimed functionality of the equipment (C).
Condition	Explains the conditions when the requirement is or is not applicable for a requirement which is classified "conditional".

Presumption of conformity stays valid only as long as a reference to the present document is maintained in the list published in the Official Journal of the European Union. Users of the present document should consult frequently the latest list published in the Official Journal of the European Union.

Other Union legislation may be applicable to the product(s) falling within the scope of the present document.

Annex B (normative): Test sites and arrangements for radiated measurements

B.1 Introduction

This annex describes the use of test sites (including antennas) to perform radiated measurements in accordance with the present document.

All the test sites and measurement arrangements described in this annex, when considered with their associated measurement uncertainty within that recommended in annex D, provide equivalent test results for the purpose of demonstrating compliance with the present document.

The information provided in annex D should be used for the interpretation of the results for the radiated measurements performed using these test sites and arrangements.

In addition, this annex describes the use of a test fixture to perform conducted (relative) measurements on equipment with integral antennas. It also defines the interference signal to be used in the channel access mechanism tests.

Subsequently the following items will be described:

- Open Area Test Site (OATS).
- Semi Anechoic Room (SAR).
- Fully Anechoic Room (FAR).
- Test fixture for relative measurements.
- Interference signal used for channel access mechanism tests.

The first three are generally referred to as free field test sites. Both absolute and relative measurements can be performed on these sites. The sites are described in clause B.2. Clause B.3 describes the antennas used in these test sites.

Where absolute measurements are to be carried out, the chamber should be verified. A detailed verification procedure is described in clause 6 of ETSI TR 102 273-4 [i.9] for the OATS, in clause 6 of ETSI TR 102 273-3 [i.8] for the SAR, and in clause 6 of ETSI TR 102 273-2 [i.7] for the FAR.

Information for calculating the measurement uncertainty of measurements on one of these test sites can be found in ETSI TR 100 028-1 [i.5] and ETSI TR 100 028-2 [i.6], ETSI TR 102 273-2 [i.7], ETSI TR 102 273-3 [i.8] and ETSI TR 102 273-4 [i.9].

B.2 Radiated test sites

B.2.1 Open Area Test Site (OATS)

An OATS comprises a turntable at one end and an antenna mast of variable height at the other end above a ground plane which, in the ideal case, is perfectly conducting and of infinite extent. In practice, while good conductivity can be achieved, the ground plane size has to be limited. A typical OATS is shown in figure B.1.

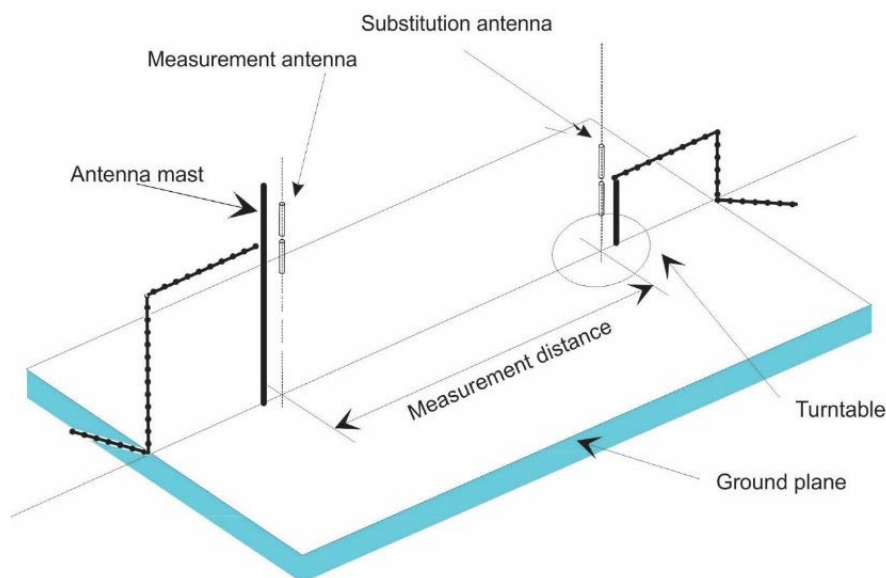

Figure B.1: A typical OATS

The ground plane creates a wanted reflection path, such that the signal received by the receiving antenna is the sum of the signals received from the direct and reflected transmission paths. The phasing of these two signals creates a unique receive level for each height of the transmitting antenna (or UUT) and the receiving antenna above the ground plane.

The antenna mast provides a variable height facility (from 1 m to 4 m) so that the position of the measurement antenna can be optimized for maximum coupled signal between antennas or between a UUT and the measurement antenna.

A turntable is capable of rotation through 360° in the horizontal plane and it is used to support the test sample (UUT) at a height of usually 1,5 m above the ground plane.

The measurement distance and minimum test site dimensions can be found in clause B.2.4. The distance used in actual measurements shall be recorded with the test results.

Further information on OATS can be found in ETSI TR 102 273-4 [i.9].

B.2.2 Semi Anechoic Room (SAR)

A SAR is (or anechoic chamber with a conductive ground plane) is an enclosure, usually shielded, whose internal walls and ceiling are covered with radio absorbing material. The floor, which is metallic, is not covered by absorbing material and forms the ground plane. The chamber usually contains an antenna mast at one end and a turntable at the other end. A typical anechoic chamber with a conductive ground plane is shown in figure B.2.

This type of test chamber attempts to simulate an ideal OATS, whose primary characteristic is a perfectly conducting ground plane of infinite extent.

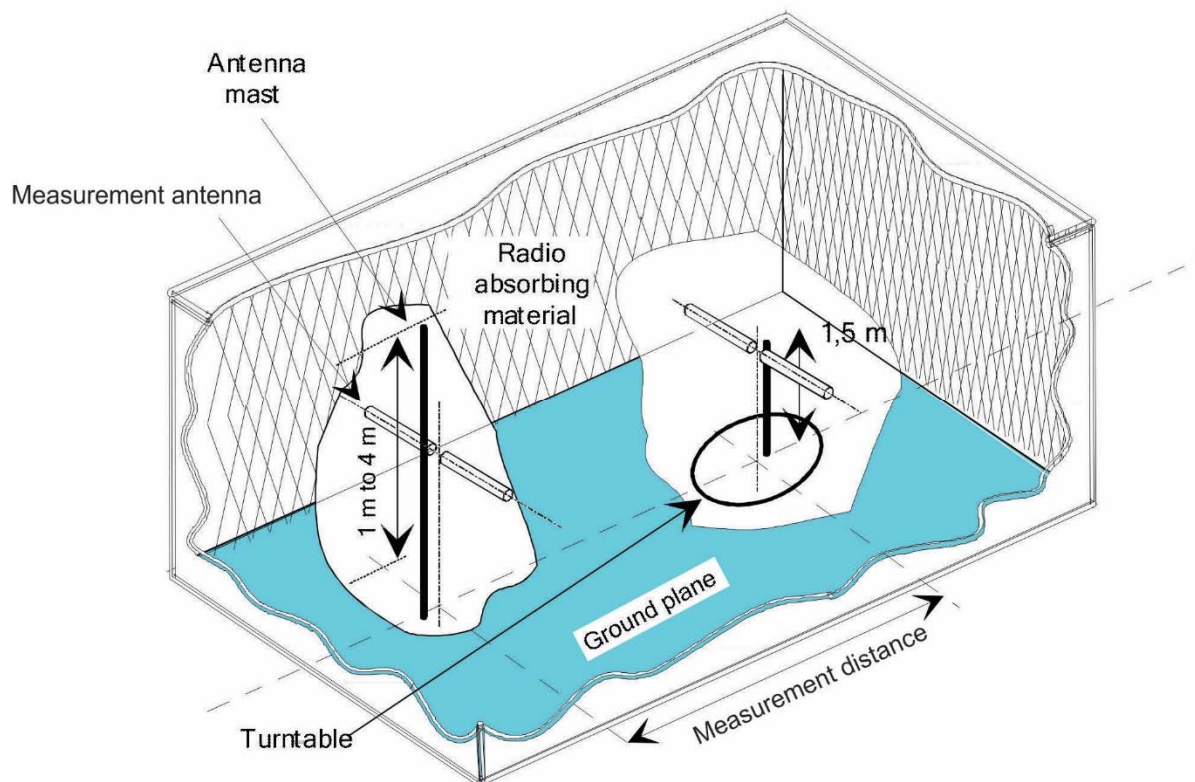

Figure B.2: A typical SAR

In this facility the ground plane creates a wanted reflection path, such that the signal received by the receiving antenna is the sum of the signals received from the direct and reflected transmission paths. The phasing of these two signals creates a unique receive level for each height of the transmitting antenna (or UUT) and the receiving antenna above the ground plane.

The antenna mast provides a variable height facility (from 1 m to 4 m) so that the position of the measurement antenna can be optimized for maximum coupled signal between antennas or between a UUT and the measurement antenna.

A turntable is capable of rotation through 360° in the horizontal plane and it is used to support the test sample (UUT) at a height of usually 1,5 m above the ground plane.

The measurement distance and minimum chamber dimensions can be found in clause B.2.4. The distance used in actual measurements shall be recorded with the test results.

Further information on SARs can be found in ETSI TR 102 273-3 [i.8].

B.2.3 Fully Anechoic Room (FAR)

A FAR is an enclosure, usually shielded, whose internal walls, floor and ceiling are covered with radio absorbing material. The chamber usually contains an antenna support at one end and a turntable at the other end. A typical FAR is shown in figure B.3.

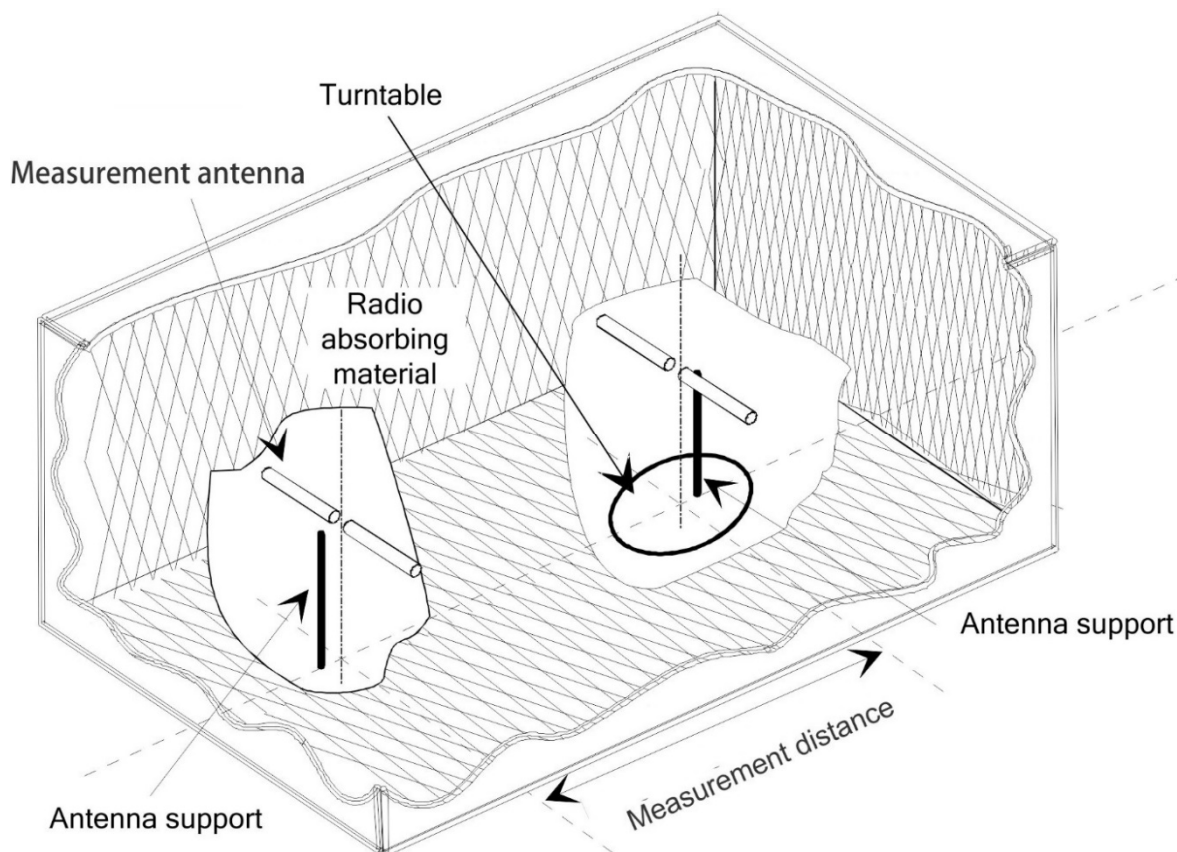

Figure B.3: A typical FAR

The chamber shielding and radio absorbing material provide a controlled environment for testing purposes. This type of test chamber attempts to simulate free space conditions.

The shielding provides a test space with reduced levels of interference from ambient signals and other outside effects, whilst the radio absorbing material minimizes unwanted reflections from the walls and ceiling which can influence the measurements. The shielding should be sufficient to eliminate interference from the external environment that would mask any signals that have to be measured.

A turntable is capable of rotation through 360° in the horizontal plane and it is used to support the UUT at a height of usually 1 m above the absorbing material.

The measurement distance and minimum chamber dimensions can be found in clause B.2.4. The distance used in actual measurements shall be recorded with the test results.

Further information on FARs can be found in ETSI TR 102 273-2 [i.7].

B.2.4 Measurement distance

The measurement distance should be chosen in order to measure the UUT at far-field conditions. The minimum measurement distance between the equipment and the measurement antenna should be λ or $r_m \gg \frac{D^2}{\lambda}$, whichever is greater.

λ = wavelength in m

r_m = minimum measurement distance between UUT and measurement antenna in m

D = largest dimension of physical aperture of the largest antenna in the measurement setup, in m

$\frac{D^2}{\lambda} =$ distance between outer boundary of radiated near field (Fresnel region) and inner boundary of the radiated far-field (Fraunhofer region) in m, also known as Rayleigh distance

For those measurements where these conditions cannot be fulfilled and where the measurement distance would result in measurements in the near field (e.g. while measuring spurious emissions) this should be noted in the test report and the additional measurement uncertainty should be incorporated into the results.

B.3 Antennas

B.3.1 Introduction

Antennas are needed for the radiated measurements on the three test sites described in clause B.2. Depending on its use, the antenna will be designated as measurement antenna or substitution antenna.

B.3.2 Measurement antenna

The measurement antenna is used to determine the field from the UUT and from the substitution antenna. When the test site is used for the measurement of receiver characteristics, the antenna is used as the transmitting device.

The measurement antenna should be mounted on a support capable of allowing the antenna to be used in either horizontal or vertical polarization. Additionally, on an OATS or SAR the height of the centre of the antenna above the ground should be variable over the specified range (usually 1 m to 4 m).

In the frequency band 30 MHz to 1 000 MHz, biconical or Logarithmic Periodic Dipole Antennas (LPDA) are recommended. Above 1 GHz, horn antennas or LPDA are recommended.

The measurement antenna does not require an absolute calibration.

B.3.3 Substitution antenna

The substitution antenna shall be used to replace the UUT in substitution measurements.

The substitution antenna shall be suitable for the frequency range, and the return loss of the antenna shall be taken into account when calculating the measurement uncertainty.

The reference point of the substitution antenna shall coincide with the volume centre of the UUT when its antenna is internal or with the point where an external antenna is connected to the UUT.

The distance between the lower extremity of the antenna and the ground shall be at least 30 cm.

The substitution antenna shall be calibrated. For below 1 GHz, the calibration is relative to a half-wave dipole, while above 1 GHz, an isotropic radiator is the reference.

B.4 Test fixture

B.4.1 Introduction

Conducted measurements may be applied to equipment provided with a (temporary) antenna connector, e.g. by means of a spectrum analyser.

In the case of integral antenna equipment with no external (temporary) antenna connector(s) provided, a test fixture can be used to allow relative measurements to be performed according to the procedure in clause B.4.3 as well as normalized measurements according to the procedure in clause B.4.4 as well as level independent measurements to clause B.4.5.

B.4.2 Description of the test fixture

The test fixture shall provide a means of coupling to the radio frequency output(s) of the UUT.

The impedance of the external connection to the test fixture shall be 50 Ω at the operating frequencies of the equipment.

The performance characteristics of the test fixture under normal and extreme test conditions shall be such that:

- a) the coupling loss shall be limited to ensure a sufficient dynamic range of the setup;
- b) the variation of coupling loss with frequency shall not cause errors exceeding ± 2 dB;
- c) the coupling device shall not include any non-linear elements.

B.4.3 Using the test fixture for relative measurements at the lower and upper extreme temperatures

For relative measurements related to requirements where testing needs to be repeated at the lower and upper extreme temperatures the following steps shall be performed:

Step 1:

Perform the measurement under normal conditions on a test site for radiated measurements as described in clause B.2. This will result in an absolute value for the requirement being tested. Record this value.

Step 2:

Put the equipment with the test fixture in the temperature chamber. Perform the same measurement at normal conditions in this environment and normalize the measuring equipment to get the same reading as before in step 1.

Step 3:

Ensure that the RF coupling accuracy remains within the range specified in clause B.4.2, item b).

Step 4:

Change the temperature in the temperature chamber and perform the measurement again. Due to the normalization done in step 2, the result will be the value for this requirement at the extreme condition.

B.4.4 Using the test fixture for normalized measurements

For normalized measurements the following steps shall be performed.

Step 1:

Perform a reference measurement for the RF output power of the UUT (without test fixture) on a test site for radiated measurements as described in clause B.2. This will result in a reference value to be used for the normalization.

Step 2:

Place the UUT in the test fixture. Do not change the position of the UUT in the test fixture for the total duration of the test procedure including the normalization and the measurement.

Step 3:

Perform the RF output power measurement without correction factors for coupling.

Step 4:

Calculate the coupling loss of the test fixture by comparing the measurements from step 1 and step 3. Use the resulting coupling loss for in band measurements and for the measurement of receiver blocking. Ensure that the RF coupling accuracy remains within the range specified in clause B.4.2, item b).

B.4.5 Using the test fixture for level independent measurements

For level independent measurements the following steps shall be performed.

Step 1:

Place the UUT in the test fixture.

Step 2:

Perform the applicable measurement as further described in the relevant part of clause 5 without correction factors for coupling loss.

B.5 Arrangement of the radiated test sites

B.5.1 Introduction

This clause details procedures, test equipment arrangements and verification that should be carried out before any of the radiated test are undertaken. These schemes are common to all types of test sites described in clause B.2.

Where necessary, a mounting bracket of minimal size should be available for mounting the UUT on the turntable. This bracket should be made from low conductivity, low relative permittivity (i.e. $\frac{\epsilon}{\epsilon_0} < 1,5$) material(s) such as expanded polystyrene, balsawood, etc.

B.5.2 Power supplies for the battery powered UUT

All tests should be performed using power supplies wherever possible, including tests on UUT designed for battery-only use. For battery powered equipment, power leads should be connected to the UUT's supply terminals (and monitored with a digital voltmeter) but the battery should remain present, electrically isolated from the rest of the equipment, possibly by putting tape over its contacts.

The presence of these power cables can, however, affect the measured performance of the UUT. For this reason, they should be made to be "transparent" as far as the testing is concerned. This can be achieved by routing them away from the UUT and down to either the screen, ground plane or facility wall (as appropriate) by the shortest possible paths. Precautions should be taken to minimize pick-up on these leads (e.g. the leads could be twisted together, loaded with ferrite beads at 0,15 m spacing or otherwise loaded).

B.5.3 Site preparation

The cables to the measuring and substitution antenna should be routed horizontally away from the testing area for a minimum of 2 m (unless, in the case both types of anechoic chamber, a back wall is reached) and then allowed to drop vertically and out through either the ground plane or screen (as appropriate) to the test equipment. Precautions should be taken to minimize pick up on these leads (e.g. dressing with ferrite beads, or other loading). The cables, their routing and dressing should be identical to the verification set up.

NOTE: For ground reflection test sites (i.e. anechoic chambers with ground planes and OATS) which incorporate a cable drum with the antenna mast, the 2 m requirement may be impossible to show conformance with.

Calibration data for all items of test equipment should be available and valid. For test, substitution and measuring antennas, the data should include gain relative to an isotropic radiator (or antenna factor) for the frequencies of the test. Also, the VSWR of the substitution and measuring antennas should be known.

The calibration data on all cables and attenuators should include insertion loss and VSWR throughout the entire frequency range of the tests. All VSWR and insertion loss figures should be recorded in the log book results sheet for the specific test.

Where correction factors/tables are required, these should be immediately available.

For all items of test equipment, the maximum errors they exhibit should be known along with the distribution of the error, e.g.:

- cable loss: $\pm 0,5$ dB with a rectangular distribution;
- measuring receiver: 1,0 dB (standard deviation) signal level accuracy with a Gaussian error distribution.

At the start of measurements, system checks should be made on the items of test equipment used on the test site.

B.6 Coupling of signals

B.6.1 General

The presence of leads in the radiated field may cause a disturbance of that field and lead to additional measurement uncertainty. These disturbances can be minimized by using suitable coupling methods, offering signal isolation and minimum field disturbance (e.g. optical coupling).

B.6.2 Data signals

Isolation can be provided by the use of optical, ultrasonic or infra-red means. Field disturbance can be minimized by using a suitable fibre optic connection. Ultrasonic or infra-red radiated connections require suitable measures for the minimization of ambient noise.

B.7 Interference signals used for channel access mechanism tests

B.7.1 Additive White Gaussian Noise (AWGN) test signal

This test signal shall be a continuous (100 % duty cycle) Gaussian noise signal of 20 MHz bandwidth:

- When testing the capability to detect other transmissions in case of multi-channel operation using option 1 (see clause 5.4.8.3.2.3.1), the AWGN test signal shall be present in any of the channels used for the multi-channel operation. However, if the test is performed sequentially (see clause 5.4.8.3.2.3.1, step 2, second bullet point), the AWGN test signal shall only be present in the channel being tested.
- When testing the capability to detect other transmissions in case of multi-channel operation using option 2 (see clause 5.4.8.3.2.3.2), the AWGN test signal shall only be present in a first adjacent (non-primary) channel.

B.7.2 OFDM test signal 1

OFDM test signal 1 shall consist of a continuous sequence (100 % duty cycle) of data symbols as defined in IEEE 802.11ax™-2021 [1], clause 27. This implies that OFDM test signal 1 does not contain any PHY preambles as defined in IEEE 802.11ax™-2021 [1], clause 27:

- When testing the capability to detect other transmissions in case of multi-channel operation using option 1 (see clause 5.4.8.3.2.3.1), the OFDM test signal shall be present in any of the channels used for the multi-channel operation. However, if the test is performed sequentially (see clause 5.4.8.3.2.3.1, step 2, second bullet point), the OFDM test signal shall only be present in the channel being tested.
- When testing the capability to detect other transmissions in case of multi-channel operation using option 2 (see clause 5.4.8.3.2.3.2), the OFDM test signal shall only be present in a first adjacent (non-primary) channel.

B.7.3 OFDM test signal 2

OFDM test signal 2 shall be a continuous (100 % duty cycle) NR-type OFDM test signal of 20 MHz channel bandwidth as described in ETSI TS 138 141-1 [2], clause 4.9.2.2.1 or ETSI TS 138 141-2 [3], clause 4.7.2.1:

- When testing the capability to detect other transmissions in case of multi-channel operation using option 1 (see clause 5.4.8.3.2.3.1), the OFDM test signal shall be present in any of the channels used for the multi-channel operation. However, if the test is performed sequentially (see clause 5.4.8.3.2.3.1, step 2, second bullet point), the OFDM test signal shall only be present in the channel being tested.
- When testing the capability to detect other transmissions in case of multi-channel operation using option 2 (see clause 5.4.8.3.2.3.2), the OFDM test signal shall only be present in a first adjacent (non-primary) channel.

B.7.4 Interference signal characteristics

B.7.4.1 Verification of flatness and bandwidth

The flatness and the bandwidth of the interference signal can be verified with the following procedure.

When the interference signal is used in the context of testing the capability to detect other transmissions in case of multi-channel operation using option 1 (see clause 5.4.8.3.2.3.1), flatness and bandwidth of the interference signal are verified for each channel used for the multi-channel operation.

When the interference signal is used in the context of testing the capability to detect other transmissions in case of multi-channel operation using option 2 (see clause 5.4.8.3.2.3.2), flatness and bandwidth of the interference signal are verified for a first adjacent (non-primary) channel.

Step 1:

Connect the signal generator for generating the interference signal to a spectrum analyser using the following settings:

- Centre frequency: Centre frequency of the interference signal
- Frequency span: $2 \times$ bandwidth of the interference signal
- RBW: $\sim 1 \%$ of the bandwidth of the interference signal
- VBW: $3 \times$ RBW
- Sweep points: $2 \times$ the frequency span divided by the RBW. For spectrum analysers not supporting this number of sweep points, the frequency band may be segmented
- Detector mode: Peak
- Trace mode: Trace Averaging
- Number of sweeps: Sufficient to let the signal stabilize
- Sweep time: Auto

Step 2:

Verify that the occupied bandwidth (the bandwidth containing 99 % of the signal power) of the interference signal is within a range from 80 % to 100 % of the nominal bandwidth of the UUT.

Step 3:

To ensure the flatness of the interference signal, verify that the 4 dB bandwidth of the signal (ignoring the DC notch at the centre frequency) covers at least 80 % of the occupied bandwidth of the signal.

B.7.4.2 Measurement of PSD

The PSD of the interference signal can be measured with the following procedure.

When combining multiple interference signals for verifying multi-channel operation, the procedure applies separately for each of the individual interference signals within the combination.

Connect the signal generator for generating the interference signal to a spectrum analyser using the following settings:

- Centre frequency: Centre frequency of the interference signal
- Frequency span: Bandwidth of the interference signal
- RBW: 1 MHz
- VBW: $3 \times \text{RBW}$
- Filter: Channel
- Detector mode: RMS
- Trace mode: Clear Write
- Number of sweeps: Single
- Sweep time: 1 s; the sweep time may be increased until a value where the sweep time has no impact on the RMS value of the signal

The peak value within the trace measured above is the PSD of the interference signal.

B.7.5 Waveforms for test signals

The test signals described in clause B.7.1, clause B.7.2 and clause B.7.3 can be generated by a vector signal generator. Example waveform files are contained in en_303687v010101p0.zip which accompanies the present document. In case the test signal needs to cover multiple channels, multiple (adjacent) 20 MHz signals shall be combined into a single test signal covering the channels under test.

Annex C (normative): Procedures for radiated measurements

C.1 Introduction

This annex gives the general procedures for radiated measurements using the test sites and arrangements described in annex B.

Preferably, radiated measurements shall be performed in a FAR, see clause C.3. Radiated measurements in an OATS or SAR are described in clause C.2.

C.2 Radiated measurements in an OATS or SAR

Radiated measurements shall be performed with the aid of a measurement antenna and a substitution antenna, in test sites described in annex B. The measurement set up shall be calibrated according to the procedure defined in the present annex. The UUT and the measurement antenna shall be oriented such as to obtain the maximum emitted power level. This position shall be recorded in the measurement report:

- a) The measurement antenna (device 2 in figure C.1) shall be oriented initially for vertical polarization unless otherwise stated and the UUT (device 1 in figure C.1) shall be placed on the support in its standard position and switched on.
- b) The measurement equipment (device 3 in figure C.1) shall be connected to the measurement antenna and set up according to the requirements of the test.

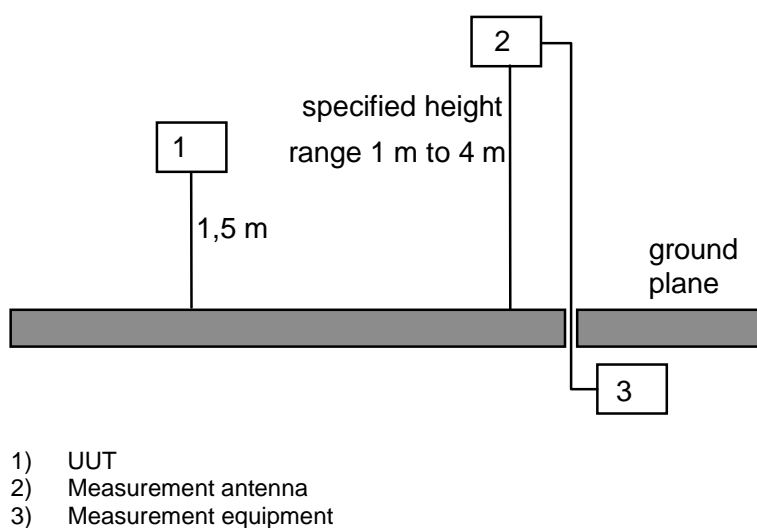

Figure C.1: Measurement arrangement for radiated measurements

- c) The UUT shall be rotated through 360° in a horizontal plane until the maximum signal strength is received at the measurement antenna.
- d) The measurement antenna shall be raised or lowered through the specified height range until a maximum is obtained. This level shall be recorded. This maximum may be a lower value than the value obtainable at heights outside the specified limits.
- e) The measurement procedure in step c) and step d) above shall be repeated for horizontal polarization.

C.3 Radiated measurements in a FAR

For radiated measurements using a FAR, the procedure is identical to the one described in clause C.2, except that the height scan in step d) is omitted.

C.4 Substitution measurement

To determine the absolute measurement value, a substitution measurement is performed. The following steps have to be performed:

- 1) Replace the UUT (depicted as device 1 in figure C.1) with the substitution antenna. The substitution antenna shall have vertical polarization.
- 2) Connect a signal generator to the substitution antenna, and adjust it to the measurement frequency.
- 3) If an OATS or a SAR is used, the measurement antenna height shall be varied within the range provided in figure C.1, to ensure that the maximum signal level is received.
- 4) Subsequently, the power of the signal generator is adjusted until the same level is obtained again at the measurement equipment.
- 5) The radiated power is equal to the power supplied by the signal generator (plus the substitution antenna gain and minus the cable losses (values in dB)).
- 6) This measurement procedure described in step 2) to step 5) above shall be repeated with horizontal polarization for the substitution antenna.

For test sites with a fixed setup of the measurement antenna(s) and a reproducible positioning of the UUT, correction values from a verified site calibration can be used alternatively.

C.5 Testing technical requirements on equipment with an integral antenna

C.5.1 Radio test suites and corresponding test sites

Table C.1 details the test site to be used for each of the radio test suites when performing radiated measurements on integral antenna equipment.

Table C.1: Radio test suites and corresponding test sites

Radio test suite	Test procedure	Corresponding test site
Nominal centre frequencies	5.4.2	B.2.1, B.2.2, B.2.3
RF output power	5.4.3	B.2.1, B.2.2, B.2.3
PSD	5.4.4	B.2.1, B.2.2, B.2.3
Transmitter unwanted emissions outside the 6 GHz WAS/RLAN band	5.4.5	B.2.1, B.2.2, B.2.3
Transmitter unwanted emissions within the 6 GHz WAS/RLAN band	5.4.6	B.2.1, B.2.2, B.2.3
Receiver spurious emissions	5.4.7	B.2.1, B.2.2, B.2.3
Channel access mechanism	5.4.8	C.5.2
Receiver blocking	5.4.9	C.5.3
Receiver selectivity	5.4.10	C.5.4
VLP NB usage with a PSD above 1 dBm/MHz	5.4.12	B.2.1, B.2.2, B.2.3

C.5.2 Channel access mechanism testing

C.5.2.1 Introduction

This clause describes how the channel access mechanism requirement (see clause 4.3.6) can be verified on integral antenna equipment, using radiated measurements.

C.5.2.2 Measurement set up

Figure C.2 describes an example of a set up that can be used to perform radiated channel access mechanism tests. This set up may need to be made inside a SAR (see clause B.2.2) or inside a FAR (see clause B.2.3) to avoid any external signal having an impact on the measurement.

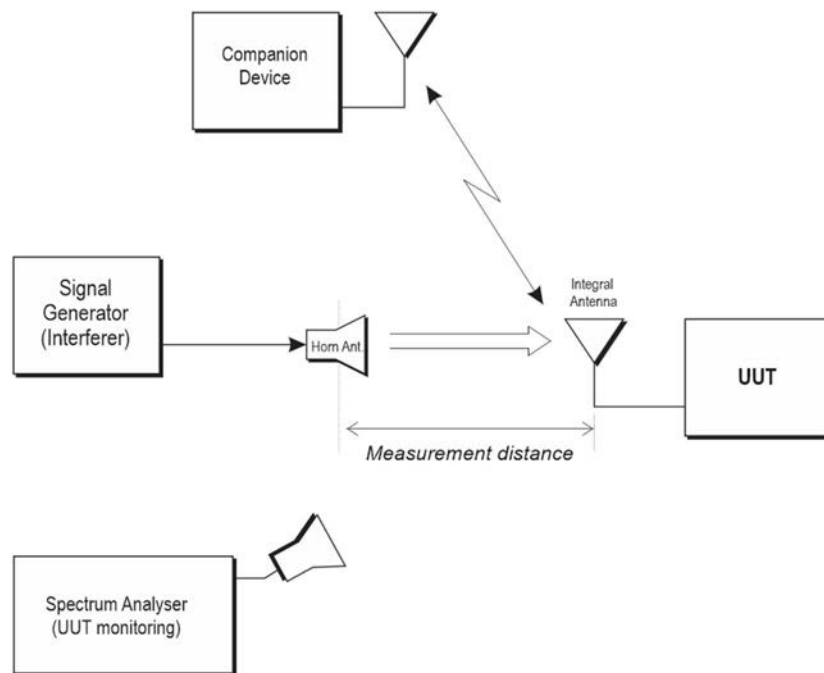

Figure C.2: Measurement set up

C.5.2.3 Calibration of the measurement set up

Before starting the actual measurement, the setup shall be calibrated. Figure C.3 shows an example of a set up that can be used for calibrating the set up given in figure C.2 using a substitution antenna and a spectrum analyser. The signal generator simulating the interference signal shall provide a signal power at the input of the substitution antenna such that the level at the interface between the UUT and its antenna assembly corresponds to the applicable EDT used for conducted measurements (see clause 5.4.8).

For test sites with a fixed setup of the measurement antenna(s) and a reproducible positioning of the UUT, correction values from a verified site calibration can be used alternatively.

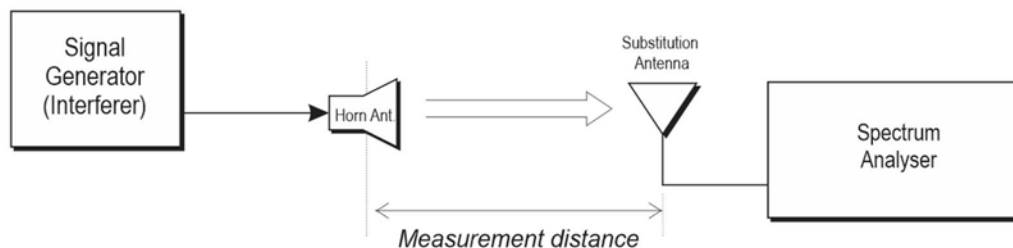

Figure C.3: Measurement set up for calibration

C.5.2.4 Test method

The test procedure shall be as follows:

- Replace the substitution antenna with the UUT once the calibration is performed.
- The UUT shall be configured/positioned for maximum EIRP towards the measurement antenna and in the horizontal plane.

NOTE: This configuration/position was recorded as part of the procedure in clause 5.4.3.2.2.

The test method is further as described under clause 5.4.8.2.2 for FBE or clause 5.4.8.3.2 for LBE.

C.5.3 Receiver blocking testing

C.5.3.1 Introduction

This clause describes how the receiver blocking (see clause 4.3.7) requirement can be verified on integral antenna equipment, using radiated measurements.

C.5.3.2 Measurement set up

Figure C.4 describes an example of a set up that can be used to perform radiated receiver blocking tests. This set up may need to be made inside a SAR (see clause B.2.2) or inside a FAR (see clause B.2.3) to avoid any external signal having an impact on the measurement.

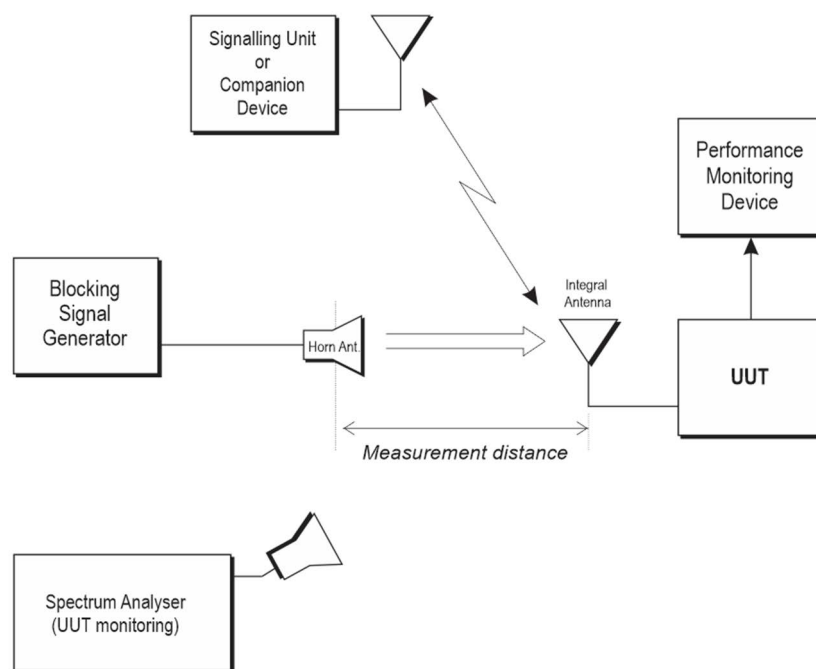

Figure C.4: Measurement set up

C.5.3.3 Calibration of the measurement set up

Before starting the actual measurement, the setup shall be calibrated. Figure C.5 shows an example of a set up that can be used for calibrating the set up given in figure C.4 using a substitution antenna and a spectrum analyser. The signal generator generating the blocking signal shall provide a signal power at the input of the substitution antenna such that the level at the interface between the UUT and its antenna assembly corresponds to the applicable level used for conducted measurements (see clause 5.4.9).

For test sites with a fixed setup of the measurement antenna(s) and a reproducible positioning of the UUT, correction values from a verified site calibration may be used alternatively.

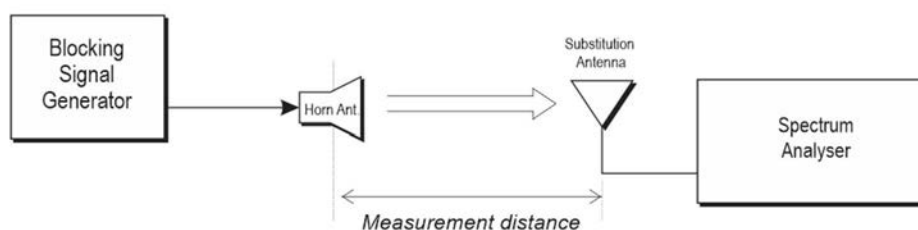

Figure C.5: Measurement set up for calibration

C.5.3.4 Test method

The test procedure shall be as follows:

- Replace the substitution antenna with the UUT once the calibration is performed.
- The UUT shall be configured/positioned for maximum EIRP towards the measurement antenna and in the horizontal plane.

NOTE: This configuration/position was recorded as part of the procedure in clause 5.4.3.2.2.

The test method is further as described under clause 5.4.9.2.1.

C.5.4 Receiver selectivity testing

C.5.4.1 Introduction

This clause describes how the receiver selectivity (see clause 4.3.8) requirement can be verified on integral antenna equipment, using radiated measurements.

C.5.4.2 Measurement set up

Figure C.6 describes an example of a set up that can be used to perform radiated selectivity tests. This set up may need to be made inside a SAR (see clause B.2.2) or inside a FAR (see clause B.2.3) to avoid any external signal having an impact on the measurement.

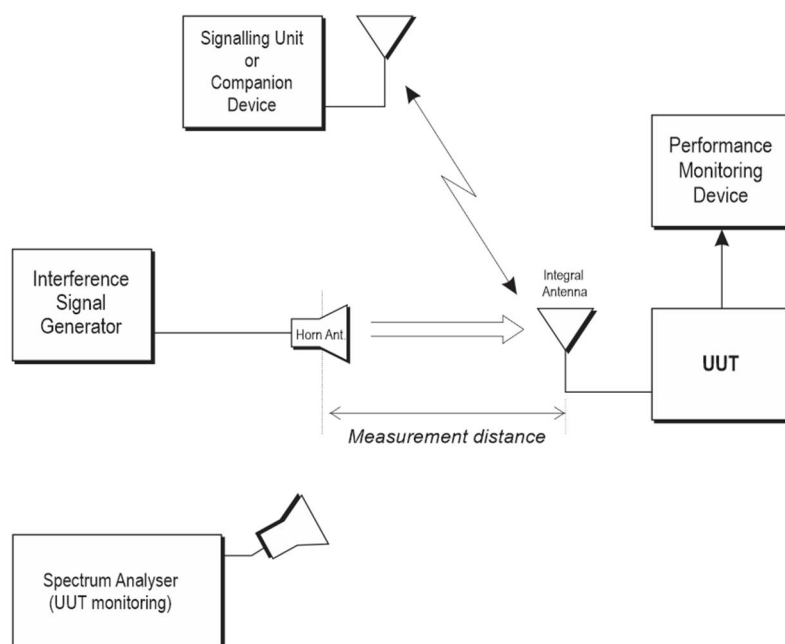

Figure C.6: Measurement set up

C.5.4.3 Calibration of the measurement set up

Before starting the actual measurement, the setup shall be calibrated. Figure C.7 shows an example of a set up that can be used for calibrating the set up given in figure C.6 using a substitution antenna and a spectrum analyser. The signal generator simulating the interference signal shall provide a signal power at the input of the substitution antenna such that the level at the interface between the UUT and its antenna assembly corresponds to the applicable level used for conducted measurements (see clause 5.4.10).

For test sites with a fixed setup of the measurement antenna(s) and a reproducible positioning of the UUT, correction values from a verified site calibration may be used alternatively.

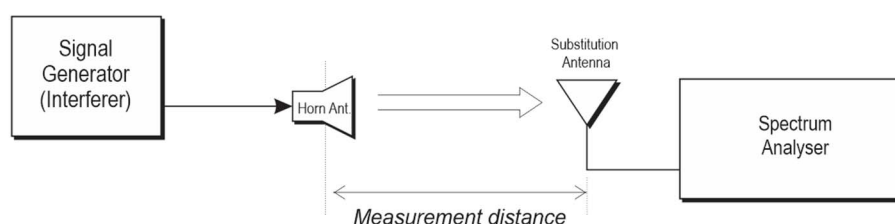

Figure C.7: Measurement set up for calibration

C.5.4.4 Test method

The test procedure shall be as follows:

- Replace the substitution antenna with the UUT once the calibration is performed.
- The UUT shall be configured/positioned for maximum EIRP towards the measurement antenna and in the horizontal plane.

NOTE: This configuration/position was recorded as part of the procedure in clause 5.4.3.2.2.

The test method is further as described under clause 5.4.10.2.1.

Annex D (informative): Maximum measurement uncertainty

The measurements described in the present document are based upon the following assumptions:

- the measured value related to the corresponding limit is used to decide whether an equipment meets the requirements of the present document;
- the value of the measurement uncertainty for the measurement of each parameter is included in the test report.

Table D.1 shows the recommended values for the maximum measurement uncertainty figures.

Table D.1: Maximum measurement uncertainty

Parameter	Uncertainty
Radio frequency	$\pm 0,001$ %
RF power, conducted	$\pm 1,5$ dB
RF power, radiated	± 6 dB
Generated signal levels, conducted	± 3 dB
Generated signal levels, radiated	± 6 dB
Spurious emissions, conducted	± 3 dB
Spurious emissions, radiated	± 6 dB
Humidity	± 5 %
Temperature	± 2 °C
Time	± 10 %

Annex E (informative): Examples of spectrum masks

E.1 Introduction

This annex contains a number of examples of spectrum masks resulting from the application of clause 4.3.4.3.2.2 on equipment configured for multi-channel operation in adjacent channels.

These masks are relative masks (relative to the PSD of the equipment) but they can never impose a limit below the absolute value of -30 dBm/MHz. See clause 4.3.4.3.2.1 (first paragraph). The examples below do not show this -30 dBm/MHz overall lowest limit as the exact position of the line representing this level depends on the PSD of the equipment. The LO exceedance referred to in clause 4.3.4.3.2.2 is not included in these examples.

E.2 Equipment configured for multi-channel operation in groups of four adjacent channels

E.2.1 Example 1

The channels in the group of adjacent channels used for multi-channel operation are numbered 1 to 4. In this example, transmissions take place simultaneously in all channels.

For this example the mask in figure 1 is applied to the group of adjacent channels with a nominal bandwidth (N) of 80 MHz. See figure E.1.

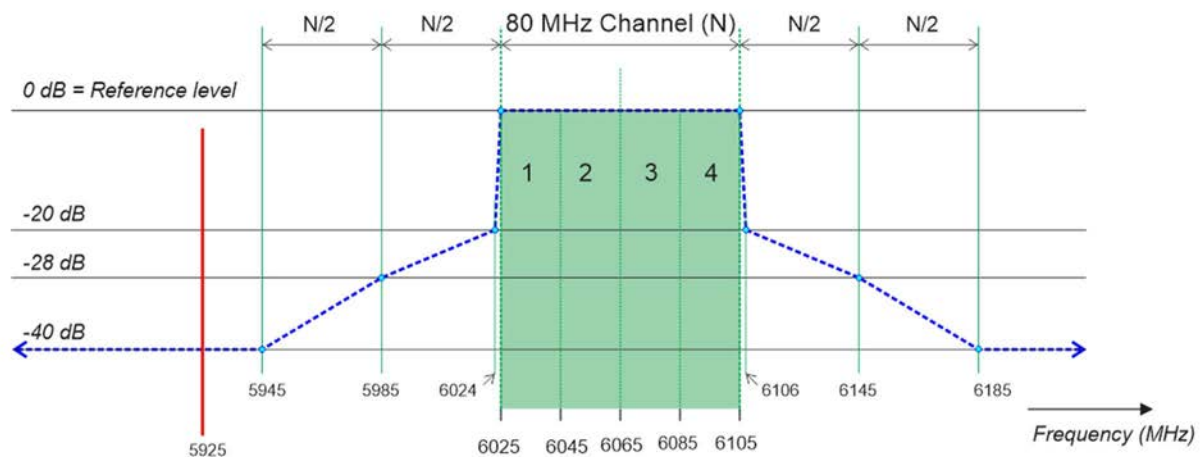

Figure E.1: Example 1

E.2.2 Example 2

The channels in the group of adjacent channels used for multi-channel operation are numbered 1 to 4. In this example, transmissions take place simultaneously in channels 2, 3 and 4.

The overall transmit spectral power mask as provided in figure E.2 is constructed from 1) the mask provided in figure 1 applied on the entire group of adjacent channels that is configured for multi-channel operation with a nominal bandwidth (N) of 80 MHz and 2) the channel edge mask provided in figure 2 applied at 6 045 MHz and at 6 105 MHz.

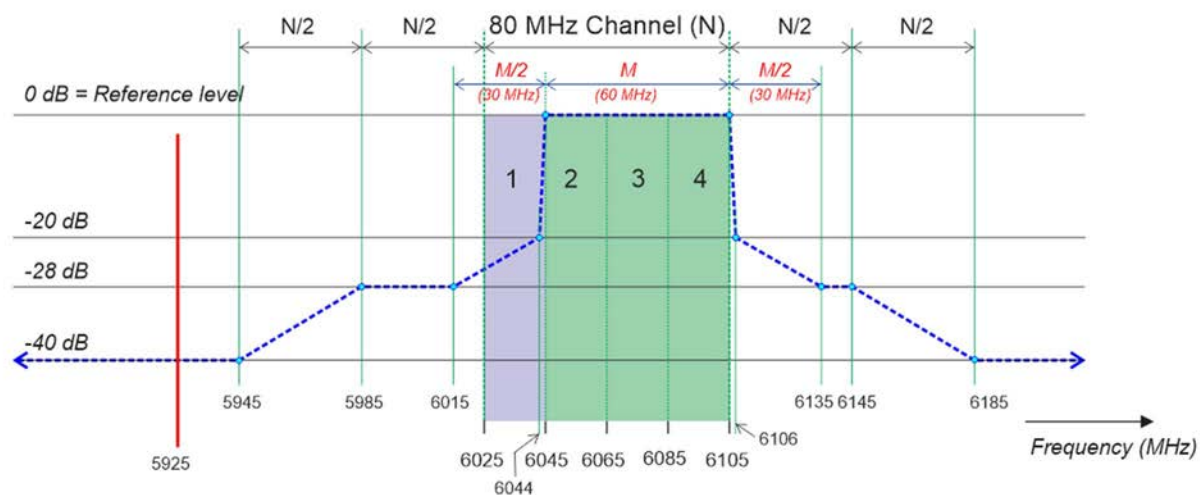

Figure E.2: Example 2

E.2.3 Example 3

The channels in the group of adjacent channels used for multi-channel operation are numbered 1 to 4. In this example, transmissions take place simultaneously in channels 1, 2 and 4.

The overall transmit spectral power mask as provided in figure E.3 is constructed from 1) the mask provided in figure 1 applied on the entire group of adjacent channels that is configured for multi-channel operation with a nominal bandwidth (N) of 80 MHz and 2) the channel edge mask provided in figure 4 (as there is only one channel not used for transmission) applied at both edges of this single channel (6 065 MHz and at 6 085 MHz).

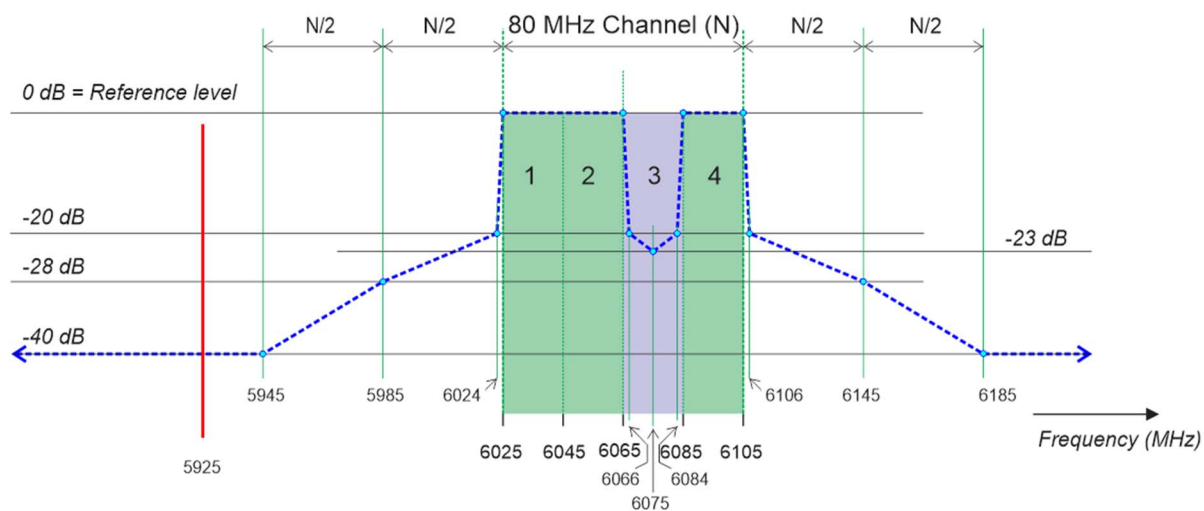

Figure E.3: Example 3

E.2.4 Example 4

The channels in the group of adjacent channels used for multi-channel operation are numbered 1 to 4. In this example, transmissions take place in channels 1 and 4.

The overall transmit spectral power mask as provided in figure E.4 is constructed from 1) the mask provided in figure 1 applied on the entire group of adjacent channels that is configured for multi-channel operation with a nominal bandwidth (N) of 80 MHz and 2) the channel edge mask provided in figure 3 applied at 6 045 MHz and at 6 085 MHz.

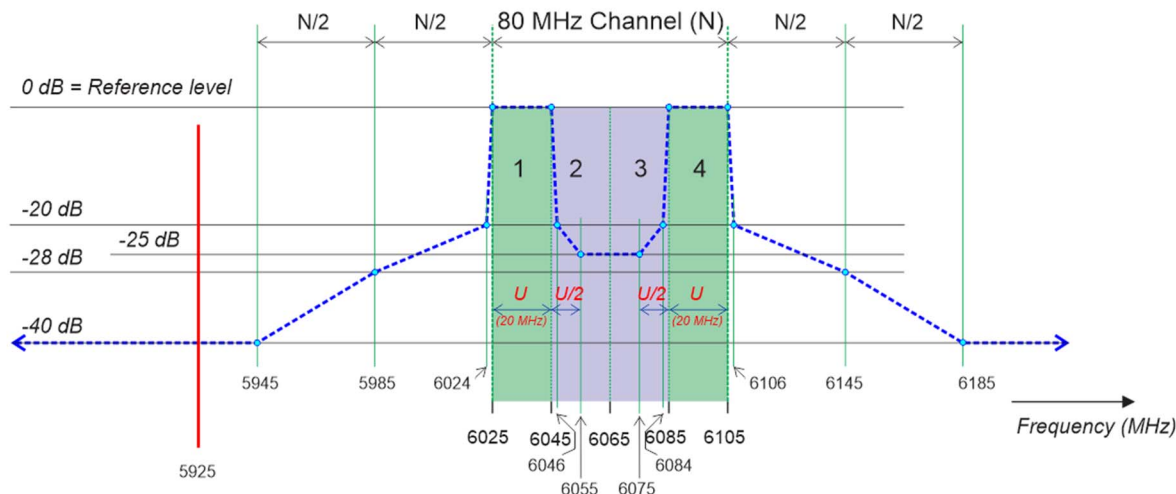

Figure E.4: Example 4

E.3 Equipment configured for multi-channel operation in 8 adjacent channels

E.3.1 Example 5

The channels in the group of adjacent channels used for multi-channel operation are numbered 1 to 8. In this example, transmissions take place simultaneously in channels 1, 2, 5, 6, 7 and 8.

The overall transmit spectral power mask as provided in figure E.5 is constructed from 1) the mask provided in figure 1 applied on the entire group of adjacent channels that is configured for multi-channel operation with a nominal bandwidth (N) of 160 MHz and 2) the channel edge mask provided in figure 3 applied at 5 985 MHz and at 6 025 MHz. The resulting mask within the channels 3 and 4 that are not used for transmission is not symmetrical as the total bandwidth of the adjacent channels used for transmission on either side of the gap is different (U_1 versus U_2).

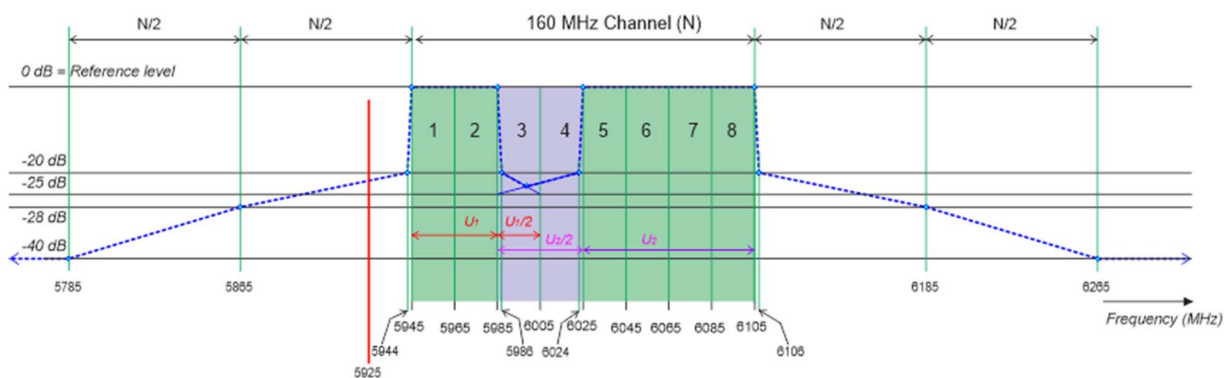

Figure E.5: Example 5

E.3.2 Example 6

The channels in the group of adjacent channels used for multi-channel operation are numbered 1 to 8. In this example, transmissions take place simultaneously in channels 1, 2, 6, 7 and 8.

The overall transmit spectral power mask as provided in figure E.6 is constructed from 1) the mask provided in figure 1 applied on the entire group of adjacent channels that is configured for multi-channel operation with a nominal bandwidth (N) of 160 MHz and 2) the channel edge mask provided in figure 3 applied at 5 985 MHz and at 6 045 MHz. The resulting mask within the channels not used for transmission (i.e. 3, 4 and 5) is not symmetrical as the total bandwidth of the adjacent channels used for transmission on either side of the gap is different (U_1 versus U_2).

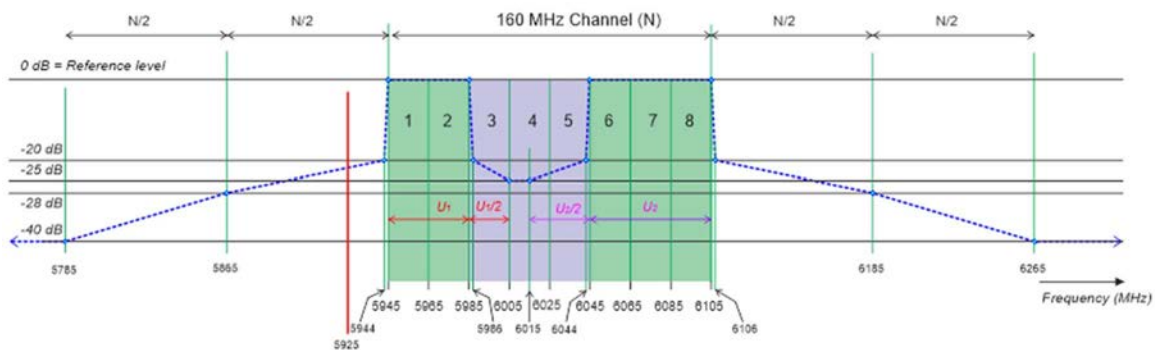

Figure E.6: Example 6

E.3.3 Example 7

The channels in the group of adjacent channels used for multi-channel operation are numbered 1 to 8. In this example, transmissions take place simultaneously in channels 1, 2, 5, 7 and 8.

The overall transmit spectral power mask as provided in figure E.7 is constructed from 1) the mask provided in figure 1 applied on the entire group of adjacent channels that is configured for multi-channel operation with a nominal bandwidth (N) of 160 MHz, 2) the channel edge mask provided in figure 3 applied at 5 985 MHz and at 6 025 MHz and 3) the channel edge mask provided in figure 4 applied at 6 045 MHz and at 6 065 MHz.

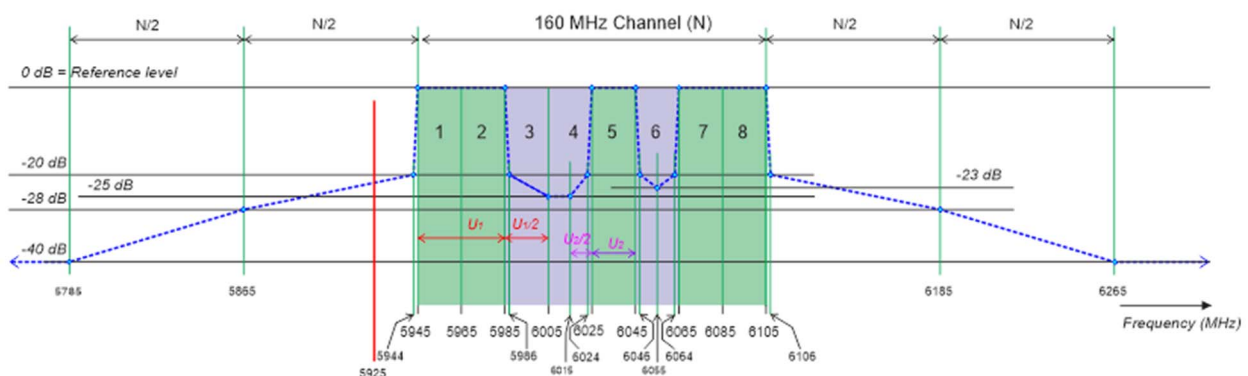

Figure E.7: Example 7

E.3.4 Example 8

The channels in the group of adjacent channels used for multi-channel operation are numbered 1 to 8. In this example, transmissions take place simultaneously in channels 2, 3, 4, 5 and 6.

The overall transmit spectral power mask as provided in figure E.8 is constructed from 1) the mask provided in figure 1 applied on the entire group of adjacent channels that is configured for multi-channel operation with a nominal bandwidth (N) of 160 MHz and 2) the channel edge mask provided in figure 2 applied at 5 965 MHz and at 6 065 MHz.

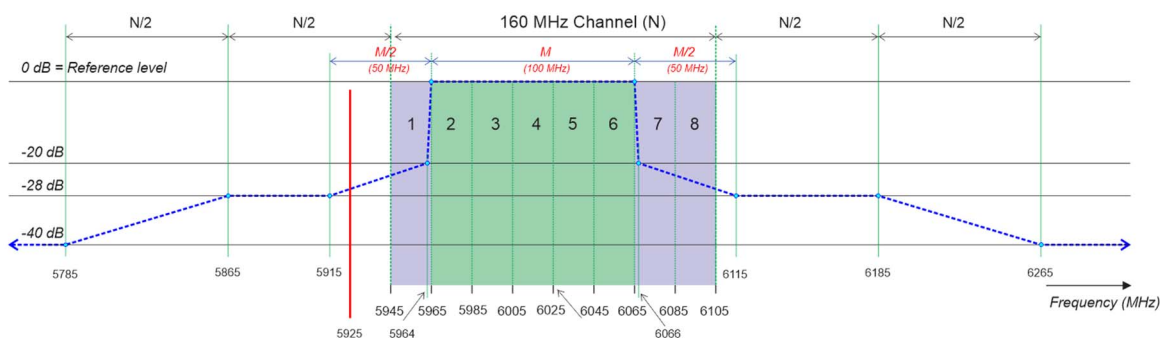

Figure E.8: Example 8

E.3.5 Example 9

The channels in the group of adjacent channels used for multi-channel operation are numbered 1 to 8. In this example, transmissions take place simultaneously in channels 1, 2, 6 and 7.

The overall transmit spectral power mask as provided in figure E.9 is constructed from 1) the mask provided in figure 1 applied on the entire group of adjacent channels that is configured for multi-channel operation with nominal bandwidth (N) of 160 MHz, 2) the channel edge mask provided in figure 2 applied at 5 945 MHz and at 6 085 MHz and 3) the channel edge mask provided in figure 3 applied at 5 985 MHz and at 6 045 MHz.

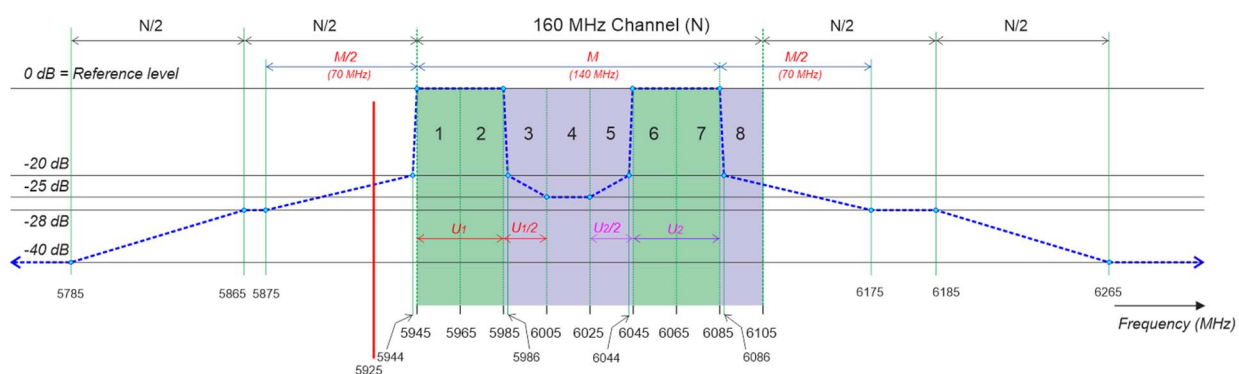

Figure E.9: Example 9

Annex F (informative): Change history

Version	Information about changes
1.1.1	First publication under Radio Equipment Directive

History

Document history		
V1.0.0	April 2022	EN Approval Procedure AP 20220726: 2022-04-27 to 2022-07-26
V1.1.0	March 2023	EN Approval Procedure AP 20230627: 2023-03-29 to 2023-06-27
V1.1.1	June 2023	Publication