

ETSI TS 103 636-4 V1.4.1 (2023-01)



DECT-2020 New Radio (NR); Part 4: MAC layer; Release 1

Reference

RTS/DECT-00378

Keywords

DECT, DECT-2020, IMT-2020, MAC, NR, radio

ETSI

650 Route des Lucioles
F-06921 Sophia Antipolis Cedex - FRANCE

Tel.: +33 4 92 94 42 00 Fax: +33 4 93 65 47 16

Siret N° 348 623 562 00017 - APE 7112B
Association à but non lucratif enregistrée à la
Sous-Préfecture de Grasse (06) N° w061004871

Important notice

The present document can be downloaded from:

<http://www.etsi.org/standards-search>

The present document may be made available in electronic versions and/or in print. The content of any electronic and/or print versions of the present document shall not be modified without the prior written authorization of ETSI. In case of any existing or perceived difference in contents between such versions and/or in print, the prevailing version of an ETSI deliverable is the one made publicly available in PDF format at www.etsi.org/deliver.

Users of the present document should be aware that the document may be subject to revision or change of status.

Information on the current status of this and other ETSI documents is available at

<https://portal.etsi.org/TB/ETSIDeliverableStatus.aspx>

If you find errors in the present document, please send your comment to one of the following services:

<https://portal.etsi.org/People/CommitteeSupportStaff.aspx>

If you find a security vulnerability in the present document, please report it through our
Coordinated Vulnerability Disclosure Program:

<https://www.etsi.org/standards/coordinated-vulnerability-disclosure>

Notice of disclaimer & limitation of liability

The information provided in the present deliverable is directed solely to professionals who have the appropriate degree of experience to understand and interpret its content in accordance with generally accepted engineering or other professional standard and applicable regulations.

No recommendation as to products and services or vendors is made or should be implied.

No representation or warranty is made that this deliverable is technically accurate or sufficient or conforms to any law and/or governmental rule and/or regulation and further, no representation or warranty is made of merchantability or fitness for any particular purpose or against infringement of intellectual property rights.

In no event shall ETSI be held liable for loss of profits or any other incidental or consequential damages.

Any software contained in this deliverable is provided "AS IS" with no warranties, express or implied, including but not limited to, the warranties of merchantability, fitness for a particular purpose and non-infringement of intellectual property rights and ETSI shall not be held liable in any event for any damages whatsoever (including, without limitation, damages for loss of profits, business interruption, loss of information, or any other pecuniary loss) arising out of or related to the use of or inability to use the software.

Copyright Notification

No part may be reproduced or utilized in any form or by any means, electronic or mechanical, including photocopying and microfilm except as authorized by written permission of ETSI.

The content of the PDF version shall not be modified without the written authorization of ETSI.

The copyright and the foregoing restriction extend to reproduction in all media.

© ETSI 2023.
All rights reserved.

Contents

Intellectual Property Rights	6
Foreword.....	6
Modal verbs terminology.....	6
1 Scope	7
2 References	7
2.1 Normative references	7
2.2 Informative references.....	7
3 Definition of terms, symbols and abbreviations.....	8
3.1 Terms.....	8
3.2 Symbols.....	8
3.3 Abbreviations	8
4 General	10
4.1 Introduction	10
4.2 MAC Architecture	10
4.2.1 General.....	10
4.2.2 MAC Structure.....	10
4.2.3 Identities	11
4.2.3.1 Network ID	11
4.2.3.2 Long Radio Device ID (Long RD ID).....	11
4.2.3.3 Short Radio Device ID (Short RD ID)	12
4.3 Service	12
4.3.1 Services provided to upper layers	12
4.3.2 Services expected from physical layer.....	13
4.4 Functions	13
4.5 Channel Structure	13
4.5.1 Logical and Transport Channels	13
4.5.2 Mapping Physical layer packet.....	14
4.6 Order of transmission and figure numbering conventions.....	14
5 MAC Layer Procedures.....	15
5.1 Spectrum Management Procedures	15
5.1.1 General.....	15
5.1.2 Operating Channel(s) and Subslot(s) selection	15
5.1.3 Last Minute Scan	16
5.1.4 Selecting RD for association.....	16
5.1.5 Beacons Transmissions	17
5.1.6 Power control.....	18
5.2 Broadcast Procedure.....	19
5.2.1 General.....	19
5.2.2 Broadcast procedure initialization	19
5.2.3 Broadcast transmission	19
5.3 Random Access procedure	19
5.3.1 General.....	19
5.3.2 Announcing Random access resources	20
5.3.3 Random Access transmission	21
5.3.4 Random Access response.....	22
5.4 Scheduled access data transfer	23
5.4.1 General.....	23
5.4.2 Allocating resources for scheduled access.....	23
5.4.3 Scheduled access transmission and reception.....	24
5.5 HARQ Operation.....	25
5.5.1 General.....	25
5.5.2 Receiver Operation	25
5.6 Multiplexing and assembly.....	26
5.7 Mobility Procedures	27

5.8	Association procedure	27
5.8.1	General.....	27
5.8.2	Sending beacon for association.....	28
5.8.3	Association initiation.....	28
5.8.4	Sending association request.....	29
5.8.5	Association response.....	29
5.8.6	Association Release	30
5.9	Security Procedures.....	30
5.9.1	Mode 1.....	30
5.9.1.1	General.....	30
5.9.1.2	Integrity protection.....	30
5.9.1.3	Ciphering.....	31
5.10	Reconfiguration.....	33
6	Protocol Data Units, formats and parameters.....	33
6.1	General.....	33
6.2	Physical Header Field.....	34
6.2.1	General.....	34
6.2.2	Coding of Feedback info.....	37
6.3	MAC PDU.....	39
6.3.1	General.....	39
6.3.2	MAC Header type.....	40
6.3.3	MAC Common header.....	41
6.3.3.1	DATA MAC PDU header.....	41
6.3.3.2	Beacon Header.....	41
6.3.3.3	Unicast Header.....	41
6.3.3.4	RD Broadcasting Header.....	42
6.3.4	MAC multiplexing header.....	42
6.4	MAC Messages and Information Elements (IEs).....	45
6.4.1	General.....	45
6.4.2	MAC messages.....	45
6.4.2.1	General.....	45
6.4.2.2	Network Beacon message.....	45
6.4.2.3	Cluster Beacon message.....	46
6.4.2.4	Association Request message.....	48
6.4.2.5	Association Response message.....	50
6.4.2.6	Association Release message.....	51
6.4.2.7	Reconfiguration Request message.....	51
6.4.2.8	Reconfiguration Response message.....	52
6.4.2.9	Additional MAC message.....	53
6.4.3	MAC information elements.....	53
6.4.3.1	MAC Security Info IE.....	53
6.4.3.2	Route Info IE.....	54
6.4.3.3	Resource allocation IE.....	54
6.4.3.4	Random Access Resource IE.....	57
6.4.3.5	RD Capability IE.....	58
6.4.3.6	Neighbouring IE.....	60
6.4.3.7	Broadcast Indication IE.....	61
6.4.3.8	Padding IE.....	62
6.4.3.9	Group Assignment IE.....	62
6.4.3.10	Load Info IE.....	63
6.4.3.11	Configuration Request IE.....	64
6.4.3.12	Measurement Report IE.....	64
6.4.3.13	Radio Device Status IE.....	65
7	Variables, and Timers.....	65
7.1	General.....	65
7.2	Variables.....	66
7.3	Timers.....	67
Annex A (normative): MAC Layer Requirements for Radio Device Capabilities.....		68
A.1	Introduction.....	68

A.2 Radio Device Capabilities68

A.2.0 Release68

A.2.1 Operating Modes68

A.2.2 System Operation68

A.2.3 Security68

A.2.4 Scheduled data transfer service68

A.2.5 Feedback Info Formats68

A.2.6 HARQ feedback delay.....69

Annex B (normative): Void70

Annex C (informative): Change History71

History72

Intellectual Property Rights

Essential patents

IPRs essential or potentially essential to normative deliverables may have been declared to ETSI. The declarations pertaining to these essential IPRs, if any, are publicly available for **ETSI members and non-members**, and can be found in ETSI SR 000 314: "*Intellectual Property Rights (IPRs); Essential, or potentially Essential, IPRs notified to ETSI in respect of ETSI standards*", which is available from the ETSI Secretariat. Latest updates are available on the ETSI Web server (<https://ipr.etsi.org/>).

Pursuant to the ETSI Directives including the ETSI IPR Policy, no investigation regarding the essentiality of IPRs, including IPR searches, has been carried out by ETSI. No guarantee can be given as to the existence of other IPRs not referenced in ETSI SR 000 314 (or the updates on the ETSI Web server) which are, or may be, or may become, essential to the present document.

Trademarks

The present document may include trademarks and/or tradenames which are asserted and/or registered by their owners. ETSI claims no ownership of these except for any which are indicated as being the property of ETSI, and conveys no right to use or reproduce any trademark and/or tradename. Mention of those trademarks in the present document does not constitute an endorsement by ETSI of products, services or organizations associated with those trademarks.

DECT™, **PLUGTESTS™**, **UMTS™** and the ETSI logo are trademarks of ETSI registered for the benefit of its Members. **3GPP™** and **LTE™** are trademarks of ETSI registered for the benefit of its Members and of the 3GPP Organizational Partners. **oneM2M™** logo is a trademark of ETSI registered for the benefit of its Members and of the oneM2M Partners. **GSM®** and the GSM logo are trademarks registered and owned by the GSM Association.

Foreword

This Technical Specification (TS) has been produced by ETSI Technical Committee Digital Enhanced Cordless Telecommunications (DECT).

The present document is part 4 of a multi-part deliverable covering the DECT-2020 New Radio (NR) technology. Full details of the entire series can be found in part 1 [1].

DECT-2020 NR is recognized in Recommendation ITU-R M.2150 [i.2] as a component RIT fulfilling the IMT-2020 requirements of the IMT-2020 use scenarios URLLC and mMTC. The Set of Radio Interface Technology (SRIT) called "DECT 5G SRIT" is involving 3GPP NR and DECT-2020 NR.

Modal verbs terminology

In the present document "**shall**", "**shall not**", "**should**", "**should not**", "**may**", "**need not**", "**will**", "**will not**", "**can**" and "**cannot**" are to be interpreted as described in clause 3.2 of the [ETSI Drafting Rules](#) (Verbal forms for the expression of provisions).

"**must**" and "**must not**" are **NOT** allowed in ETSI deliverables except when used in direct citation.

1 Scope

The present document is one of the parts of the specification of the DECT-2020 New Radio (NR).

The present document specifies the Medium Access Control (MAC) layer and interactions between the MAC layer and physical layer and higher layers.

2 References

2.1 Normative references

References are either specific (identified by date of publication and/or edition number or version number) or non-specific. For specific references, only the cited version applies. For non-specific references, the latest version of the referenced document (including any amendments) applies.

Referenced documents which are not found to be publicly available in the expected location might be found at <https://docbox.etsi.org/Reference>.

NOTE: While any hyperlinks included in this clause were valid at the time of publication, ETSI cannot guarantee their long term validity.

The following referenced documents are necessary for the application of the present document.

- [1] ETSI TS 103 636-1: "DECT-2020 New Radio (NR); Part 1: Overview; Release 1".
- [2] ETSI TS 103 636-2: "DECT-2020 New Radio (NR); Part 2: Radio reception and transmission requirements; Release 1".
- [3] ETSI TS 103 636-3: "DECT-2020 New Radio (NR); Part 3: Physical layer; Release 1".
- [4] FIPS PUB 197: "Advanced Encryption Standard (AES)".
- [5] NIST Special Publication 800-38B: "Recommendation for Block Cipher Modes of Operation: The CMAC Mode for Authentication".
- [6] ETSI TS 103 636-5: "DECT-2020 New Radio (NR); Part 5: DLC and Convergence layers; Release 1".

2.2 Informative references

References are either specific (identified by date of publication and/or edition number or version number) or non-specific. For specific references, only the cited version applies. For non-specific references, the latest version of the referenced document (including any amendments) applies.

NOTE: While any hyperlinks included in this clause were valid at the time of publication, ETSI cannot guarantee their long term validity.

The following referenced documents are not necessary for the application of the present document but they assist the user with regard to a particular subject area.

- [i.1] ETSI EN 300 175 (all parts): "Digital Enhanced Cordless Telecommunications (DECT); Common Interface (CI)".
- [i.2] Recommendation ITU-R M.2150: "Detailed specifications of the terrestrial radio interfaces of International Mobile Telecommunications-2020 (IMT-2020)".

3 Definition of terms, symbols and abbreviations

3.1 Terms

For the purposes of the present document, the following terms apply:

Fixed Termination point (FT): operational mode of an RD where the RD initiates, coordinates local radio resources, and provides information on how other RDs may connect and communicate with it

operating channel: single continuous part of the radio spectrum with a defined bandwidth where RDs transmit and/or receive as defined in ETSI TS 103 636-2 [2]

Portable Termination point (PT): operational mode of RD where RD selects another RD, which is in FT mode, for association

Radio Device (RD): device with radio transmission and reception capability which can operate in FT and/or PT mode

resource: variable length time unit defined in subslot(s) or slot(s) in the single operating channel that an RD is using for transmission or reception of a physical layer packet

NOTE: Resource can be contentious or contention free, i.e. scheduled.

slot: unit of a radio frame as defined in ETSI TS 103 636-3 [3], clause 4

subslot: unit of a radio frame as defined in ETSI TS 103 636-3 [3], clause 4

NOTE: Subslots in the frame are numbered in increasing order and the first subslot of the radio frame is number 0.

3.2 Symbols

For the purposes of the present document, the following symbols apply:

0x Value in hexadecimal
 β Fourier transform scaling factor

NOTE: As defined in ETSI TS 103 636-3 [3].

μ Subcarrier scaling factor

NOTE: As defined in ETSI TS 103 636-3 [3].

RSSI-1 RSSI-1 measurement

NOTE: As defined in ETSI TS 103 636-2 [2].

RSSI-2 RSSI-2 measurement

NOTE: As defined in ETSI TS 103 636-2 [2].

3.3 Abbreviations

For the purposes of the present document, the abbreviations given in ETSI TS 103 636-1 [1] and the following apply:

NOTE: An abbreviation defined in the present document takes precedence over the definition of the same abbreviation, if any, in ETSI TS 103 636-1 [1].

ACK Acknowledgement
 BCC Broadcast Control
 BCCH Broadcast Control Channel
 BLER Block Error Ratio
 BS Buffer Size

BSC	Beacon Scanning Control
CCC	Connection Configuration Control
CCCH	Common Control Channel
CMAC	Cipher-based Message Authentication Code
CQI	Channel Quality Indicator
CTR	Counter mode
DCCH	Dedicated Control Channel
DCH	Dedicated Channel
DF	Data Field

NOTE: As defined in ETSI TS 103 636-3 [3].

DTCH	Dedicated Traffic Channel
FO	Frame Offset
FT	Fixed Termination point
GI	Guard Interval

NOTE: As defined in ETSI TS 103 636-3 [3].

HARQ	Hybrid Automatic Repeat reQuest
HPC	Hyper Packet Counter
HW	Hardware
ID	Identity
IE	Information Element
IV	Initialization Vector
LBT	Listen Before Talk
LRC	Local Radio Control
MCS	Modulation and Coding Scheme
MIC	Message Integrity Code

NOTE: Same as Message Authentication Code.

MIMO	Multiple Input Multiple Output
MSB	Most Significant Bit
MTCH	Multicast (Broadcast) Traffic Channel
MUX	Multiplexing
NA	Not Applicable
NACK	Negative Acknowledgement
NSS	Number of Spatial Streams
OFDM	Orthogonal Frequency Division Multiplexing
PCC	Physical Control Channel
PCCH	Paging Common Channel
PCH/BCH	Paging and Broadcast Channel
PDC	Physical Data Channel
PDU	Protocol Data Unit
PSN	Packet Sequence Number
PT	Portable Termination point
PTC	Paging Transmission Control
RAC	Random Access Control
RACH	Random Access Channel
RD	Radio Device
RSSI	Received Signal Strength Indicator
SDU	Service Data Unit
SFN	System Frame Number
SNR	Signal to Noise Ratio
STF	Synchronization Training Field

NOTE: As defined in ETSI TS 103 636-3 [3].

4 General

4.1 Introduction

The objective of this clause is to describe the MAC protocol layer architecture, used identities, used transport channels and mapping MAC PDU into physical layer packet.

4.2 MAC Architecture

4.2.1 General

This clause describes a model of the MAC i.e. it does not specify or restrict implementations.

4.2.2 MAC Structure

The overall MAC structure is depicted in Figure 4.2.2-1. MAC provides DTCH and MTCH logical channels for transferring higher layer data. The flow of the higher layer data and MAC internal messages to physical channels is depicted with black solid lines. The grey dashed line corresponds to MAC internal control interfaces between MAC functions and the MAC control entity.

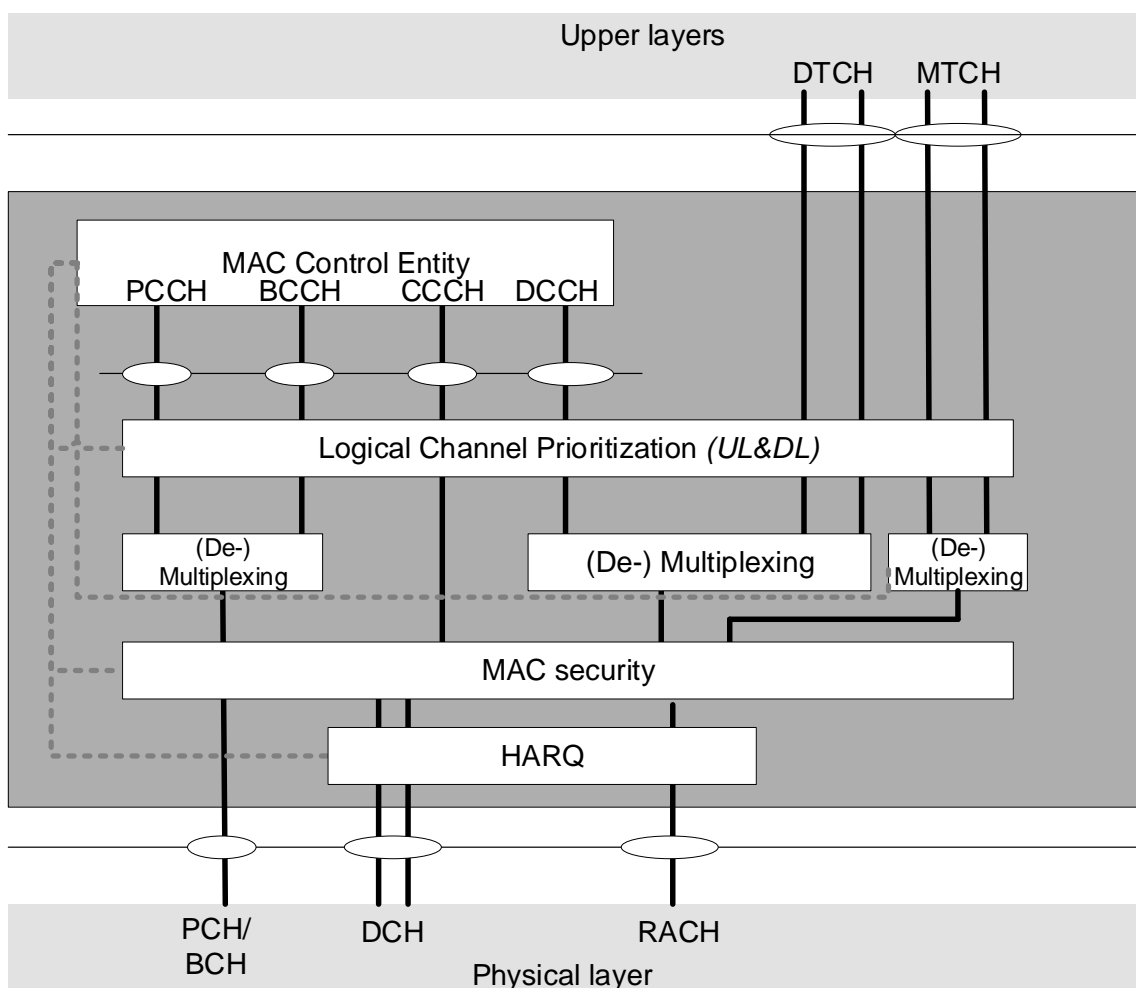

Figure 4.2.2-1: MAC structure overview

The MAC layer of the Radio Device (RD) handles the transmission and reception of the following transport channels:

- Paging and Broadcast Channel (PCH/BCH);

- Dedicated Channel (DCH);
- Random Access Channel (RACH).

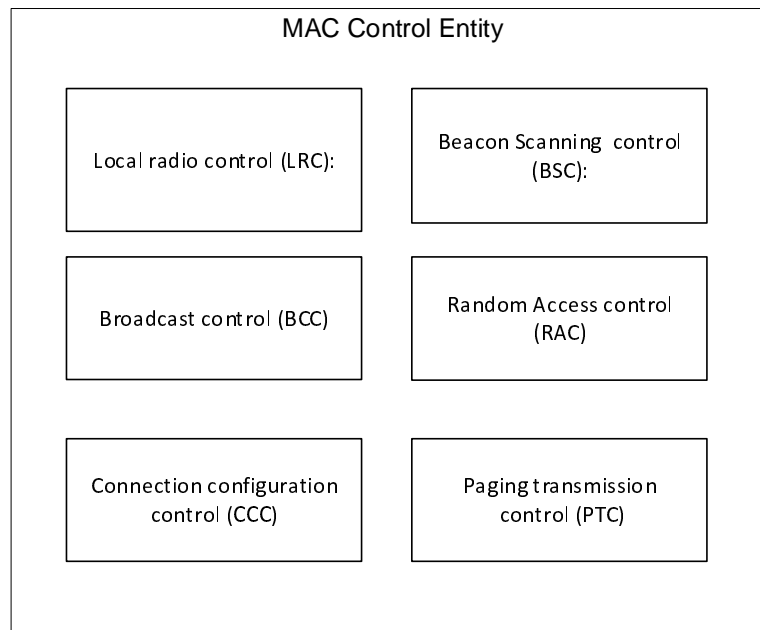

Figure 4.2.2-2: MAC control Entity

The MAC control entity is depicted in Figure 4.2.2-2 and described in clause 4.4.

4.2.3 Identities

4.2.3.1 Network ID

The Network ID has a length of 32 bits, and the first 24 MSB bits are used to identify a DECT-2020 network uniquely from other DECT-2020 networks. The 8 LSB bits of the network are selected locally to minimize collision with other networks.

The network ID is transmitted periodically in beacon messages as plain text enabling other RDs to detect which network the transmitted beacon belongs to.

The last 8 LSB bits of the network ID are transmitted in the PHY control field of the packet as defined in clause 6.2.

The 24 MSB bits of the network ID are provided to the PHY layer to initialize the PDC scrambling sequence in clause 7.6.6 of ETSI TS 103 636-3 [3].

The network ID can be set to any other value than 0x00000000.

NOTE: The Network ID should be set in such a manner that the maximum likelihood for a unique identity for a network is obtained due to randomness of 2 to the power of 32.

4.2.3.2 Long Radio Device ID (Long RD ID)

The Long radio device ID has a length of 32 bits, and it identifies a radio device uniquely in a single DECT-2020 network. The coding of the Long RD ID is defined in Table 4.2.3.2-1. An RD obtains the Long RD ID as part of the authentication process over the DECT-2020 NR system or via manual provision or by using other communication channels.

The Long RD ID is used in:

- an association procedure to recognize associating RDs uniquely;
- MAC layer security procedures;

- packet routing in mesh system operation to identify the original source and the final target receiver of the routed data packet as defined in ETSI TS 103 636-5 [6].

Table 4.2.3.2-1: Use of Long RD ID address space

Address type	Address field	Comment
Reserved address	0x00000000	Shall not be used as it is considered as not defined.
Backend address	0xFFFFFFFF	Indicates that a packet is to be delivered out from the DECT-2020 system, i.e. to a backend system.
Broadcast address	0xFFFFFFFF	This address can be used to indicate that a packet needs to be received by all RDs in the system when performing packet routing.
Long RD ID	0x00000001-0xFFFFFFFF	This address space is used to identify a radio device uniquely in a DECT-2020 system.
Multicast address	0x00000001-0xFFFFFFFF	The system configuration defines a range of addresses that are used as multicast addresses in the given system. A multicast group can use any of those addresses. When the receiver address of the packet is a multicast group the packet is intended for all members of that group. An RD can be part of one or multiple multicast groups.

The Long RD ID is transmitted in a MAC PDU to:

- identify the receiver and the transmitter of the packet in the association procedure for exchanging Short RD IDs; or
- when the transmitter of the MAC PDU considers that there is a potential confusion on Short RD IDs.

When an RD is initiating authentication over a DECT-2020 NR network the RD can use a random value or application defined value as a Long RD ID from the Long RD ID space defined in Table 4.2.3.2-1, if no valid Long RD ID value is available from the previous authentication procedures.

4.2.3.3 Short Radio Device ID (Short RD ID)

The Short radio device ID has a length of 16 bits, and it identifies a radio device locally in a DECT-2020 NR network. The coding of the Short RD ID is defined in Table 4.2.3.3-1.

The Short RD ID is used in the PHY control field as in transmitter or receiver fields to identify the transmitter and the receiver of the packet.

The Short RD ID is exchanged during the association procedure between RDs performing association so that linkage between Short RD ID and Long RD ID is obtained by both associating RD. Each radio device randomly selects a Short RD ID value that it uses in the association.

Table 4.2.3.3-1: Use of Short RD ID address space

Address type	Address field	Comment
Reserved address	0x0000	Shall not be used as it is considered as not defined
Short RD ID	0x0001-0xFFFF	This address space is used to identify RD in the PHY control field
Broadcast address	0xFFFF	This address can be used to indicate that transmission is a broadcast MAC PDU

4.3 Service

4.3.1 Services provided to upper layers

The MAC layer provides the following services to upper layers:

- data transfer;
- radio resource allocation.

4.3.2 Services expected from physical layer

The MAC layer expects the following services from the physical layer:

- data transfer services in physical layer packets;
- measurements.

4.4 Functions

The MAC layer supports the following control functions in the MAC control entity:

- Local Radio Control (LRC): This function is overall in charge of the radio resource in the local coordination area, when the RD coordinates local radio resources, i.e. operates as an FT.
- Paging Transmission Control (PTC): This function controls paging message transmission when the RD coordinates local radio resources, i.e. operates as FT.
- Broadcast Control (BCC): This functionality controls Beacons and other broadcast/multicast transmissions.
- Random Access Control (RAC): This functionality is in charge of random access transmissions.
- Beacon Scanning Control (BSC): This function controls scanning operations.
- Connection Configuration Control (CCC): This functionality controls multiplexing, mapping data to transport channels, MCS, HARQ configuration, MAC security and handovers with LRC.

The MAC layer supports the following transmission functions:

- paging and broadcast signalling;
- control signalling;
- radio resource management by channel selection and channel access procedures;
- logical channel prioritization;
- mapping between logical channels and transport channels;
- multiplexing of MAC SDUs from one or different logical channels onto the MAC PDU to be delivered to the physical layer via transport channels;
- demultiplexing of MAC SDUs to one or different logical channels from transport blocks MAC PDU delivered from the physical layer via transport channels;
- error correction through HARQ;
- MAC layer security by providing integrity protection and ciphering.

4.5 Channel Structure

4.5.1 Logical and Transport Channels

The MAC layer provides data transfer services on logical channels. To accommodate different kinds of data transfer services, multiple types of logical channels are defined i.e. each supporting transfer of a particular type of information.

Each logical channel type is defined by what type of information is transferred. The MAC has a set of internal logical channels and logical channels to higher layers.

The MAC layer has the control and traffic channels listed in Table 4.5.1-1.

Table 4.5.1-1: Logical channels provided by MAC

Logical channel name	Acronym	Available for higher layers	Control channel	Traffic channel
Broadcast Control Channel	BCCH		X	
Paging Control Channel	PCCH		X	
Common Control Channel	CCCH		X	
Dedicated Control Channel	DCCH		X	
Dedicated Traffic Channel	DTCH	X		X
Multicast Traffic Channel	MTCH	X		X

The MAC sublayer uses the transport channels listed in Table 4.5.1-2.

Table 4.5.1-2: Transport channels used by MAC

Transport channel name	Acronym	Downlink	Uplink
Paging and Broadcast Channel	PCH/BCH	X	
Dedicated Channel	DCH	X	X
Random Access Channel	RACH	X	X

Logical channels can be mapped as described in Table 4.5.1-3.

Table 4.5.1-3: Channel mapping

Transport channel \ Logical channel	PCH/BCH	DCH	RACH
BCCH	X		
PCCH	X		
CCCH			X
DCCH	X	X	X
DTCH		X	X
MTCH	X		X

4.5.2 Mapping Physical layer packet

In packet transmissions transport channels are mapped to Physical Data Channels (PDC) carried in a physical layer packet. Additionally, the MAC provides the number of used spatial streams, and the content of the Physical Layer Control Field to the physical layer. The Physical Layer Control Field is mapped to a Physical Control Channel (PCC) of the physical layer packet.

4.6 Order of transmission and figure numbering conventions

The transmission order is Big endian and left to right:

- A list of octets is transmitted 1st octet first.
- For each octet, bits are numbered 0 to 7 according to the transmission order. Bit 0 is transmitted first (ascending transmission order).
- When bits are numbered in any other MAC structure, they are also numbered according to transmission order.

Whenever an octet or other container represents a numeric quantity the left most bit in the diagram and thus, the first to be transmitted, is the high order or most significant bit.

For octets, the bit labelled 0 is the most significant bit and bit 7 is the least significant bit.

When referring to the bits of a numerical value, ordinal numbers starting by 1st can be used to refer to the bits. 1st bit means the most significant bit, 2nd bit means the second MSB (note that if the value is placed in an octet the first bit is transmitted in bit 0). Last bit, 2nd last, 3rd last, etc. can be used to refer to the 3 least significant bits of the number.

NOTE: The transmission order (endianness and bit transmission order) is identical to DECT (ETSI EN 300 175 [i.1], parts 1 to 8). However the numbering convention in figures (bit numbering in octets carrying numeric values) has been reversed to follow generally accepted conventions.

5 MAC Layer Procedures

5.1 Spectrum Management Procedures

5.1.1 General

An RD shall support the set of cognitive radio spectrum management features, defined in clause 5.1.

In each connection between two RDs, one RD is in FT mode and the other RD is in PT mode. The RD in FT mode coordinates local radio resources and provides information on how other RDs may connect and communicate with it, whereas the RD in PT mode performs functions based on information provided by the RD in FT mode.

The radio resource coordination in an FT mode RD is performed with the following functions:

- Operating carrier(s) and subslot(s) selection by using a background scan as defined in clause 5.1.2.
- Transmitting beacon(s) to enable other RDs to identify, measure and initiate association with the RD, as defined in clause 5.1.5.
- Providing and configuring radio communication parameters of the connections with associated RDs.
- Selecting the optimum power level as defined in clause 5.1.6.

An RD in PT mode operates based on information provided by RDs in FT mode and performs the following functions:

- Selecting RD for the association as defined in clause 5.1.4.
- Performing configured measurements before initiating transmissions to an RD in FT mode as defined in clause 5.1.4 or clause 5.7.
- Selecting the optimum power level as defined in clause 5.1.6.

A single RD can operate both in FT and PT modes simultaneously, i.e. in FT mode it coordinates radio resources for other RDs connecting to it as well as in PT mode it is connected to another RD, which operates in FT mode.

5.1.2 Operating Channel(s) and Subslot(s) selection

When an RD initiates FT mode operation, the RD shall initiate the background scan process for finding the operating channels and subslots, which are fulfilling the operating conditions.

The background scan may be done in any order on the supported band(s) and channel(s). For each channel, the RD shall measure at least the duration of the variable *SCAN_MEAS_DURATION* and obtain the RSSI-1 value for each measured subslot.

For each measured subslot on the channel, the RD shall consider whether the subslot is "free", "possible" or "busy". The subslot status is considered as:

- "free" if $\max(\text{RSSI-1}) \leq \text{RSSI_THRESHOLD_MIN}$;
- "possible" if $\text{RSSI_THRESHOLD_MIN} < \max(\text{RSSI-1}) \leq \text{RSSI_THRESHOLD_MAX}$;
- "busy" if $\max(\text{RSSI-1}) > \text{RSSI_THRESHOLD_MAX}$.

within the duration of the measured subslot.

The RD may stop the background scan process and initiate beacon transmission as defined in clause 5.2, if the number of "free" or "possible" subslots is \geq *SCAN_SUITABLE* at *SCAN_MEAS_DURATION* at least on one channel and the number of "free" or "possible" measured subslots is sufficient for the operation of the RD.

After measuring the supported channels, the RD should select an operating channel(s) or consecutive operating channels in the following manner:

- if any channel or consecutive channels where all subslots are "free", is found:
 - select the channel or the consecutive channels;
- else:
 - select the channel or consecutive channels that has the lowest number of "busy" subslots; and
 - if multiple channels or consecutive channels have the same number of "busy" subslots:
 - select the channel or consecutive channels that has the lowest number of "possible" subslots.

After selecting the operating channel(s) the RD shall start the timer *scanStatusValid*. The RD shall consider the scan valid until the timer *scanStatusValid* expires.

If *DECT_PROTECTED* is TRUE the RD may start the timer *dectProTime* (subtracting the age of the measurement of this channel) and consider status of "free" or "possible" of the subslot is valid until *dectProTime* expires.

The RD shall exclude subslots measured as "busy" or subslots not having valid "free" or "possible" status in resource announcements in the beacon message. The RD may measure a subslot previously measured as "busy" at any time to check whether it can be considered as "free" or "possible".

The RD may re-start the timer *scanStatusValid* when the RD has updated measurement results of all the "free" and "possible" subslots, without a need to measure those subslot(s) on which the RD is transmitting to or the RD is receiving transmission on it, i.e. any transmission that it is coordinating.

The RD may re-initiate the Operating Channel(s) and Subslot(s) selection procedure at any time. The RD should re-initiate the Operating Channel(s) and Subslot(s) selection procedure when the number of busy subslots \geq *CHANNEL_LOADED* at *SCAN_MEAS_START*, or the number of "free" or "possible" measured subslots is not sufficient for the operation of the RD.

5.1.3 Last Minute Scan

When the variable *DECT_PROTECTED* is true and the timer *dectProTime* is not running, the RD shall consider that subslot status is no longer valid for a given slot, which is not in use by the RD.

The RD shall update the status of a subslot on a given carrier by performing an RSSI-1 measurement on 1 and/or 0,5 frames before the slot and update the subslots status "free", "possible" or "busy" as defined in clause 5.1.2 before announcing the resource available for transmission or before initiating its own transmission on the subslot.

When performing measurements the RD may:

- start the timer *dectProTime*.

5.1.4 Selecting RD for association

When an RD desires to establish a connection with another RD it scans frequency channels to detect network and/or cluster beacon messages containing desired network ID(s).

When an RD detects network beacon(s) from another RD, the RD may:

- Initiate the reception of a cluster beacon based on information obtained from the network beacon.

When an RD detects cluster beacons from another RD, the RD shall:

- Evaluate the radio quality by RSSI-2 measurement from the detected beacon whether it meets the minimum quality level for radio connection.

The minimum quality level is defined as:

- $RSSI-2 \geq MIN_SENSITIVITY_LEVEL + MIN_QUALITY$.
- If the RD has detected multiple beacons from different RDs, which all meet the minimum quality level for radio connection:
 - if the detected beacon(s) contains the route info IE and optionally load info IE:
 - the RD should calculate its own route cost, as defined in clause 6.4.3.2, to detected RD(s) and select the RD that provides the lowest route cost value for the association;
 - if the lowest route cost value is obtained from multiple RDs:
 - from those RDs, the RD should select the RD that provides the highest RSSI-2 value for the association;
 - else:
 - the RD should select the RD that provides the highest RSSI-2 value for the association.
- If none of the detected cluster beacons meets the minimum quality level, the RD may:
 - initiate association to the RD providing the highest RSSI-2 value; or
 - continue scanning frequency channels to detect network and cluster beacon messages.

5.1.5 Beacons Transmissions

To enable other RDs to identify, measure and initiate association with the RD, an RD in FT mode initiates the transmission of the beacon messages. The identification of the RD and the network is done by the Network ID and the Long RD ID included in the MAC Common header of the MAC PDU carrying a beacon message.

There exist two types of beacon messages that are transmitted periodically by the FT:

- Network Beacon message, as defined in clause 6.4.2.2.
- Cluster Beacon message, as defined in clause 6.4.2.3.

The transmission periods of the Network and Cluster Beacon messages can be different.

The Network Beacon message is used to allow RDs to find the network rapidly. The Network Beacon message can be transmitted on a limited set of channel(s) to reduce other RDs' search time. When an RD is detecting the Network Beacon message, it measures RSSI-2 to compare the detected RD for the association, clause 5.1.4, and for Mobility, clause 5.7, purposes.

The Network Beacon message indicates the operating channel of the RD in FT mode and the next transmission timing of the Cluster Beacon message as illustrated in Figure 5.1.5-1.

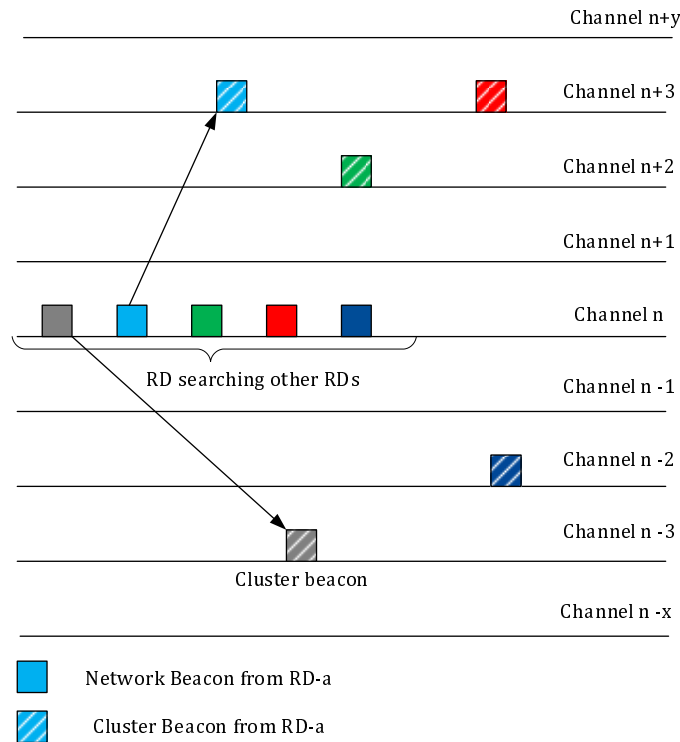

NOTE: Different colours represent different RDs sending Network and Cluster Beacon messages.

Figure 5.1.5-1: Examples of Network and Cluster Beacon transmissions

The Cluster Beacon message is used to provide frame and slot timing used by the RD in FT mode. The Cluster Beacon provides the parameters for initiating association with the RD and it is used to coordinate radio resources in the cluster. The MAC PDU carrying the Cluster Beacon Message can be amended with additional optional IEs.

All beacon message transmissions are done as defined in clause 5.2.

5.1.6 Power control

When transmitting broadcast messages the transmission power of the RD can be configured to the RD or the RD can independently adjust the used TX power.

When transmitting a unicast message the used TX power shall be the minimum that provides the target BLER of the single transmission of the transmitted MAC PDU on the selected MCS.

If the Clusters Max TX power field is received in a Network beacon or a Cluster beacon message, the RD shall:

- consider indicated TX power as the maximum TX power allowed for unicast transmissions in this cluster;

else:

- consider the Transmit Power field of the Physical Layer Control Field: Type 1, used to transmit Network or Cluster Beacon message, as a maximum TX power allowed for unicast transmissions in this cluster.

In all cases, the used TX power shall be equal to or less than the maximum allowed by the regulations in a given operating channel.

5.2 Broadcast Procedure

5.2.1 General

The broadcast procedure provides means for an RD to broadcast messages for different purposes. These purposes are:

- broadcasting beacon messages;
- broadcasting signalling or application data for all other RDs of the network; or
- broadcasting signalling or application data for a multicast group of the network.

5.2.2 Broadcast procedure initialization

An RD may start sending broadcast messages after it has selected operating channel(s) and the timer *scanStatusValid* is running or it has selected another RD for the association.

For initiating broadcast a transmission the RD shall:

- if *DECT_PROTECTED* is TRUE and *dectProTime* is not running:
 - take actions defined in clause 5.1.3;
- select the resource that is "free" or "possible";
- take actions defined in clause 5.2.3.

5.2.3 Broadcast transmission

The RD shall set the content of the broadcast transmission as follows:

- if the message is a beacon message:
 - use Physical Layer Control Field: Type 1;
- else:
 - use Physical Layer Control Field: Type 2 and set Receiver Identity to broadcast ID;
- if MAC security is used:
 - set MAC Security to 10 in MAC header Type and include Security Info in the Common MAC header.

5.3 Random Access procedure

5.3.1 General

Resources for random access transmissions per operating channel are broadcasted in beacons by RDs. Random access transmission and resources are defined by the following parameters:

- **RACH resources slots:** Indicates slot index of the first and last slot in a frame for RACH resources.
- **Repetition:** Defines how often RACH resources are repeated in coming frames.
- **RACH Period:** Defines how many frames RACH allocation is valid after the frame where the beacon was transmitted.
- **Maximum Random Access TX time:** Defines the maximum Packet length for a single RACH transmission.
- **Response Window:** Time window when a RACH response can be expected by the RD sending the Random access transmission. If not received, the transmitting RD considers that the RACH transmission failed.

- **CW_MIN**: Defines the minimum value where the **CW_CURRENT** can be reduced.
- **CW_MAX**: Defines the maximum value where the **CW_CURRENT** can be increased.

NOTE: Allowed parameter value ranges for the above parameters are operating band specific with possible default values.

Slots indicated as random access resources are divided into multiple start positions where the transmission can be initiated. Start positions are counted from the beginning of a random access slot, and are 0, 1, 2, 3... times the duration of STF and GI field, with the given μ -factor as defined in ETSI TS 103 636-3 [3]. The random access resource partition to start positions is depicted in Figure 5.3.1-1.

Transmissions to random access resources are controlled by a Listen Before Talk (LBT) protocol, with exponential back off delay. The timer *rachBackOff* is started with a random value picked by the RD and it has uniform distribution between 0 and **CW_CURRENT**, taking values multiple of the sum of the STF and the GI with given μ -factor as defined in ETSI TS 103 636-3 [3]. Transmission to the random access is allowed after timer *rachBackOff* expires and the channel is detected as "free" or "possible" at least **MINIMUM_LBT_PERIOD** before this. The channel is considered as "free" or "possible" based on thresholds defined in clause 5.1.2. The **MINIMUM_LBT_PERIOD** is the duration of the sum of the STF, and the GI before the start position with given the μ -factor as defined in ETSI TS 103 636-3 [3].

The LBT and random delay is depicted in Figure 5.3.1-1.

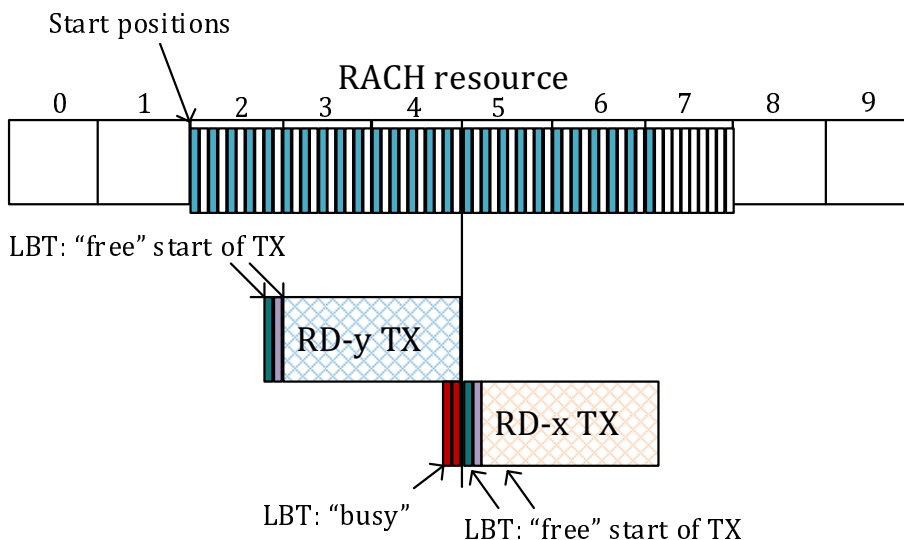

Figure 5.3.1-1: Random Access transmissions

5.3.2 Announcing Random access resources

An RD may start announcing random access resources with a beacon message. Before announcing resources, the RD should evaluate local interference conditions and select resources where interference is below the "busy level" as defined in clause 5.1.2. If variable **DECT_PROTECTED** is TRUE, the maximum value for timer *dectProTime* for Random access resources equals to cluster beacon period indicated in the Cluster Beacon message as defined in clause 6.4.2.3.

If variable **DECT_PROTECTED** is TRUE and the timer *dectProTime* is not running, before announcing random access resources in a beacon message the RD shall:

- check one frame in advance whether resources to be announced are "free", or "possible" as defined in clause 5.1.3;
- remove all slots that are measured as "busy".

After announcing random access resources, the RD should detect transmission as defined in clause 5.5:

- for all detected transmissions send a random access response and HARQ feedback in the RACH response window.

During the reception of random access resources, an RD may measure slots whether resources are "free", "possible" or "busy" from other systems transmissions for updating random access resources. When performing measurements, the RD may:

- start the timer *dectProTime*;
- update the next announced random access resources based on the measurement result.

5.3.3 Random Access transmission

Before transmitting to random access resources the RD shall:

- obtain random access parameters listed in clause 5.3.1;
- if variable *DECT_PROTECTED* is TRUE and the value of the validity obtained from Random Access Resource IE as defined in clause 6.4.3.4 has a value 0xFF or longer than Cluster Beacon period:
 - consider the RACH resource to be valid a minimum of 2 times the cluster beacon period and the received validity value;
- use Physical Layer Control Field: Type 2;
- select the highest MCS and highest available number of spatial streams that maximizes throughput;
- set feedback info bits accordingly;
- prepare the MAC PDU for transmission as defined in clause 5.6 and initiate the backoff process as follows:
 - pick a random value between 0 and *CW_CURRENT*, and start timer *rachBackOff* with the value;
- keep *rachBackOff* running during random access resources;
- at least *MINIMUM_LBT_PERIOD* before the *rachBackOff* expires, measure the channel whether it is "free" or "possible" for transmission;
- if the channel is detected as "free" or "possible" as defined in clause 5.1.2:
 - if the prepared MAC PDU fits to the remaining random access resources:
 - initiate random access transmission;
 - else:
 - defer random access transmission to the next occurrence of random access resources;
- else channel is detected as "busy" as defined in clause 5.1.2:
 - initiate the backoff process as defined above.

NOTE: After transmitting to random access the RD may re-initiate the random access transmission procedure to the same random access resources.

5.3.4 Random Access response

After performing a random access transmission, the RD should receive a response within a time indicated as the random access response window.

If the RD does not receive a response message as PHY control indicating neither ACK nor NACK is detected during the random access response window:

- considers that there was a collision in the transmission;
- if *CW_CURRENT* is less than *CW_MAX*:
 - double the value of *CW_CURRENT*;
- initiate a new random access procedure as defined in clause 5.3.3.

If the RD receives a response message as PHY control indicating either ACK or NACK is detected during the random access response window:

- consider that there was no collision;
- set the *CW_CURRENT* to *CW_MIN*;
- if random access response message CRC of the DATA part fails:
 - initiate a new random access transmission as defined in clause 5.3.3 and include HARQ feedback as defined in clause 5.5;
- if the random access response message CRC of the Data part is OK:
 - act based on the received message and include HARQ feedback as defined in clause 5.5;
 - if the received message includes resource allocation for transmission:
 - use the allocated resources for the next transmission;
 - else:
 - initiate new random access transmission as defined in clause 5.3.3.

If the RD receives a broadcast message containing Broadcast Indication IE (see clause 6.4.3.7) indicating Random Access response and the RD finds its own Short RD ID from the Broadcast Indication IE during the random access response window:

- consider that the random access transmission was successful;
- set the *CW_CURRENT* to *CW_MIN*;
- if the Broadcast Indication IE indicates that MAC PDU transmitted in the random access message was successfully decoded:
 - clear the MAC PDU from the TX buffer;
- else:
 - initiate re-transmission of the MAC PDU;
- if the received MAC PDU includes resource allocation:
 - use allocated resources for the next (re)transmission;
- else if MAC buffers are empty:
 - procedure ends;

- else:
 - initiate a new random access transmission as defined in clause 5.3.3.

5.4 Scheduled access data transfer

5.4.1 General

The scheduled access data transfer is performed by using pre-assigned resources between an RD in FT mode and an RD in PT mode. The FT part of the communication assigns the resources for the RD in PT mode to transmit and receive. Figure 5.4.1-1 depicts an example of resource allocation signalled with a single Resource allocation IE as defined in clause 6.4.3.3.

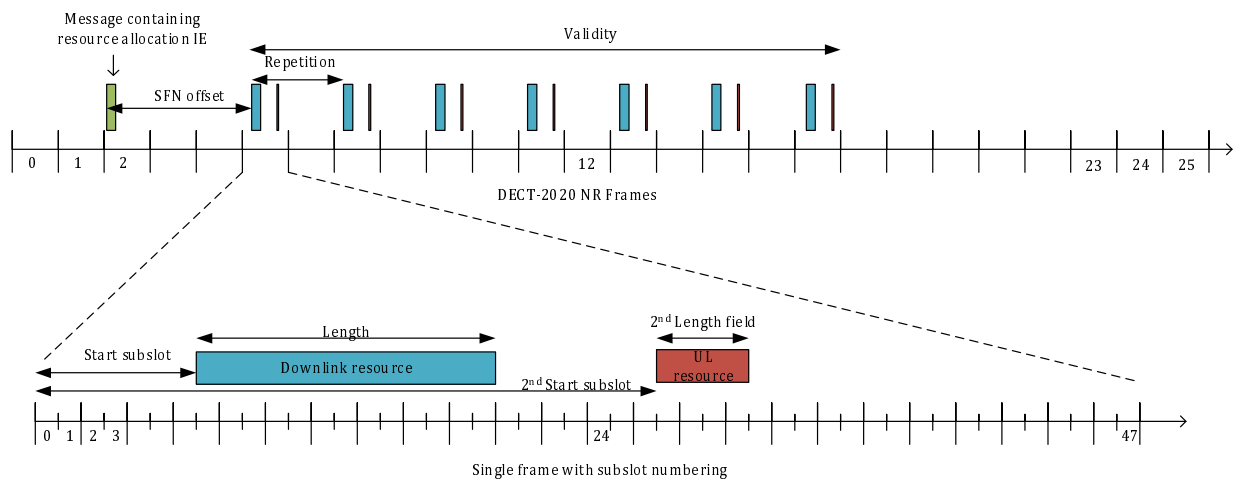

Figure 5.4.1-1: Example resource allocation with downlink and uplink resource assignment, with $\mu = 1$

5.4.2 Allocating resources for scheduled access

An RD in FT mode may allocate resources for scheduled access for communication after it has selected operating channel(s) and while timer *scanStatusValid* is running as defined in clause 5.1.2.

To allocate resources for scheduled transmission the RD in FT mode shall:

- if *DECT_PROTECTED* is TRUE and *dectProTime* is not running:
 - take actions defined in clause 5.1.3;
- select the resource(s) resources that are "free";
- if an insufficient amount of "free" resources are available:
 - select the resource(s) that are "possible";
- if an insufficient amount of "free" or "possible" resources is available, the RD may:
 - perform operating channel(s) and subslot(s) selection as defined in clause 5.1.2;
 - select the resource(s) that are "free" or "possible";
 - if an insufficient amount of "free" or "possible" resources is detected while considering all supported channels and subslots, the RD may:
 - select the resource(s) maximizing the number of resources detected as "free" or "possible" and minimizing the number of possible resources detected as "busy";

- if *DECT_PROTECTED* is TRUE and assigned resources are repeated:
 - configure repetitions such that resources occupy the same subslot(s), in any radio frame where they occur;
- send selected resources in Resource allocation IE.

NOTE: In case resource repetition is longer than 20 ms, or RD defers multiple consecutive transmissions, an interference scenario may occur where a DECT connection starts utilizing the same or partially the same resources without the capability to detect such an interference condition to initiate handover to other resources. DECT-2020 NR FT should consider this interference scenario at resource assignment and during scheduled access data transfer.

5.4.3 Scheduled access transmission and reception

The RD shall:

- receive all resources configured as *receive* as follows:

- perform HARQ operation as defined in clause 5.5;

NOTE: The transmitter may decide not to request HARQ feedback and not to use HARQ re-transmission for a given transmission.

- maintain reception of beacon messages, if the RD is not able to receive the beacon due to scheduled reception or transmission resource:
 - operations on scheduled resources take precedence;
- transmit on resource configured as *transmit* scheduled resource as follows:
 - use Physical Layer Control Field: Type 2;
 - select the highest MCS and highest available number of spatial streams that maximize throughput with the given QoS requirement;
 - set feedback info bits;
 - prepare MAC PDU as defined in clause 5.6;
 - if MAC security is used:
 - take actions defined in clause 5.9;
 - if the RD does not have any valid MAC SDUs or MAC IEs or pending HARQ processes or other PHY feedback, the RD should:
 - defer the transmission to that resource;
- monitor the quality of the resources used for reception using RSSI-2 and SNR measurements;
- if the RD is operating in FT mode, and the quality of the resources used for reception or transmission, or both, do not meet the target quality of the service:
 - start the timer *dectScheduledResourceFailure*;
 - re-assign new resources for scheduled access data transfer as defined in clause 5.4.2;
 - after successful re-assignment of the resources:
 - stop timer *dectScheduledResourceFailure*;
 - if *dectScheduledResourceFailure* expires:
 - stop transmission on the scheduled resources;

- release the association with the other RD;
- if the RD is operating PT mode, and the quality of the resources used for reception or transmission, or both, do not meet the target quality of the service:
 - start the timer *dectScheduledResourceFailure*;
 - prepare a Measurement Report IE as defined in clause 6.4.3.12, to be transmitted in next scheduled resource;
 - continue receiving and transmitting using the scheduled resources;
 - if new resources for scheduled access data transfer are received from the RD in FT mode:
 - start using the new resources;
 - stop timer *dectScheduledResourceFailure*;
 - if *dectScheduledResourceFailure* expires:
 - stop transmission on the scheduled resources;
 - release the association with the other RD;
 - initiate selection of an RD for the association as defined in clause 5.1.4.

5.5 HARQ Operation

5.5.1 General

RD shall support HARQ combining based on physical layer control field signalling. Based on the packet coding result an RD sends ACK or NACK feedback in the physical control field of the physical layer packet. The processing time for creating the feedback is two subslots or as indicated by the RD in the *HARQ feedback delay* field in RD capability IE as defined in clause 6.4.3.5. This results that feedback shall be included in the transmission at subslot $n+3$, or at subslot $n+HARQ\ feedback\ delay+1$, or the next transmitted packet after that, where n indicates the subslot where the reception of the packet ended. High layer signalling can be used to delay HARQ feedback signalling.

5.5.2 Receiver Operation

An RD performing reception:

- If the PHY Control field is not decodable:
 - no transmission is detected by the PHY layer, i.e. signal level is so low that received energy is considered noise or below the detection threshold or CRC of the PHY layer fails:
 - ignore the resource - the RD does not generate negative or positive feedback.
- If a MAC PDU is received with PHY Control Field with Header Format: 000:
 - if the PHY Control Field indicates with a short network ID and receiver ID that the data is intended for it:
 - decode the PHY control bits to define the MCS, Packet length, Transmission mode, HARQ process number, Redundancy version and New data indication status;
 - if the New Data Indication defines that the transmitted information is a retransmission of an ongoing HARQ process:
 - combine the received transmission with the existing data in the buffer belonging to the same HARQ process buffer;
 - attempt to decode the DATA part;

- if the CRC of the DATA part is correct:
 - transmit a positive Acknowledgement (ACK) to the transmitter using the physical layer feedback bits in the next packet transmission; and
 - process the MAC PDU further;
- else if the CRC of the DATA part is indicating incorrect reception:
 - transmit a negative acknowledgement (NACK) to the transmitter using the physical layer feedback bits in next packet transmission; and
 - store the received packet (in soft symbols) in the HARQ process buffer;
- else:
 - ignore the received packet - MAC does not generate ACK or NACK feedback message.
- If a MAC PDU is received by the correct RD with PHY Control Field with Header Format: 001:
 - if the PHY Control Field indicates with a short network ID and receiver ID that the data is intended for it:
 - decode the PHY control bits to define the MCS, Packet length, and Transmission mode;
 - attempt to decode the DATA part;
 - if the CRC of the DATA part is correct:
 - process the MAC PDU further;
 - else if the CRC of the DATA part is indicating incorrect reception:
 - ignore the received DATA part;
 - else:
 - ignore the received packet.

5.6 Multiplexing and assembly

The RD shall perform multiplexing to a MAC PDU as follows:

- calculate the maximum MAC PDU size based on available resources, selected MCS, TX power and the highest available number of spatial streams;
- obtain the maximum MAC PDU content size by taking into account:
 - MAC header type;
 - MAC Common header;
 - if security is used:
 - security info IE included;
 - MIC;
- fill MAC PDU content in the following order:
 - all MAC message(s);
 - individual MAC IE(s);
 - all MAC SDUs from higher layer signalling flow;
 - all MAC SDUs from user plain data flow in priority order;

- if the MAC PDU content is not full:
 - include padding into the MAC PDU content to obtain the next possible packet length;
- set used MCS, transmission power, number of streams and packet length fields in PHY control field 1.

5.7 Mobility Procedures

Radio Device mobility is based on RSSI-2 measurement and the RD reselection decision to change association from the previous RD in FT mode to another RD in FT mode. The RD may initiate and complete the association to the target RD in FT mode before releasing the association from the source RD in FT mode. Additionally, an RD may maintain an association to multiple RDs simultaneously.

The RD in PT mode and associated with other RD should perform mobility procedures as follows:

- scan supported channels periodically to detect network and cluster beacons from other RDs;
- when detecting network or cluster beacon perform RSSI-2 measurement on the detected beacon;
- if $RSSI-2_{\text{detected}} > RSSI-2_{\text{Own}} + RELATIVE_QUALITY$:
 - associate *countToTrigger* for the detected RD and decrease the counter *countToTrigger* by 1;
- else:
 - reset the *countToTrigger* to value stored in variable *COUNT_TO_TRIGGER* obtained from the cluster beacon;
- if *countToTrigger* is zero, consider RD for target RD for mobility:
 - receive the cluster beacon from the RD, and if it enables association:
 - initiate association towards the RD as defined in clause 5.8;
- else:
 - maintain scanning for detecting other RDs and measure a detected RD in its next cluster beacon interval.

NOTE 1: An RD may release the association to the source RD before or after completing the association.

NOTE 2: Additionally the RD may fail to send an Association Release message to the source RD due to a loss of radio connection.

NOTE 3: An RD may stop measuring detected other RD, if the RSSI-2 value of the detected RD is low compared to the existing RD. This is left to the implementation. Criteria for stopping measurement can be e.g. $RSSI-2_{\text{detected}} < RSSI-2_{\text{Own}} - 6$ dB.

5.8 Association procedure

5.8.1 General

Figure 5.8.1-1 presents the association signalling procedure. The purpose of association signalling is to initiate unicast data exchange between two RDs. A single RD may have an active association to multiple other RDs simultaneously. When an association is established, it is maintained until it is explicitly released by either party.

NOTE: The explicit release may not always be possible due to radio conditions, mobility, or due to other reasons.

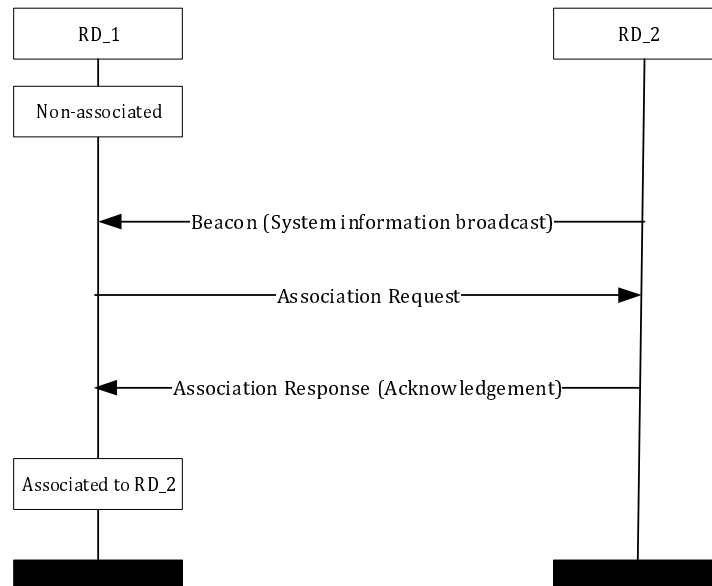

Figure 5.8.1-1: Association signalling

5.8.2 Sending beacon for association

RD_2 enables the association procedure by broadcasting beacon messages as defined in clause 5.2.1. The reception of a beacon allows other RDs to associate with RD_2. The beacon message has at least the following parameters:

- Control Header type 1 is used.
- Short RD ID of RD_2 is included in the PHY control field of the beacon frame as the transmitter address of the frame.
- The rest of the PHY control fields are set accordingly.
- The Network ID and the Long RD ID of RD_2 are included in Beacon Header, clause 6.3.3.2, of the MAC PDU and transmitted as plain text.

The beacon content of the MAC PDU can be transmitted as plain text without MIC or ciphered with the inclusion of the MIC provided by the MAC security.

If the beacon content is sent plain text RD_2 provides association for any other RDs that may or may not have MAC security key(s) available from authentication with the backend.

If the beacon content is ciphered the association is only possible for RDs that already have MAC security keys available.

5.8.3 Association initiation

RD_1 initiates the association procedure by performing the following actions:

- generate Short RD ID as a random value:
 - the RD_1 uses random value generation so that all values available in 2 power of 16 have equal probability to be obtained from the process;
- exclude reserved values (Table 4.2.3.3-1) from the selection;
- scan the radio environment to detect possible other RDs for the association as defined in clause 5.1.2:
 - during this process it may detect multiple DECT-2020 physical layer transmissions (Unicast or broadcast);

- if it detects the same short RD value as it has randomly allocated in the first step:
 - perform the random Short RD ID allocation again;
- if it detects a suitable other RD for the association:
 - send an Association Request message to detected RD.

5.8.4 Sending association request

The RD sends an Association Request message as a CCCH message as follows:

- uses parameters provided in Beacon;
- uses actions defined in clause 5.3;
- sets the Short RD ID in the PHY control field of the transmitter address of the physical layer packet;
- sets the receiver address of the PHY control field as the Short RD ID of RD_2;
- includes its own Long RD ID and the receiver's Long RD ID in the Unicast Header, clause 6.3.3.3, of the MAC PDU, to be transmitted as plain text;
- if the beacon was ciphered and/or RD has MAC security keys available:
 - cipher and integrity protect the rest of the MAC PDU part as defined in clause 5.9;
- if the beacon was not ciphered and RD does not have MAC security keys:
 - send an association request without ciphering and integrity protection;
- after sending the association request message:
 - initiate reception of the association response message as instructed by the beacon message.

5.8.5 Association response

When RD_2 receives the association request it performs the following actions for sending a response:

- considers if it can accept association;
- checks whether it has knowledge of whether the indicated Short RD ID is in use by another RD with a different Long RD ID.

If RD_2 can accept the association request, it sends an Association Response message as CCCH message by setting:

- set its own Short RD ID as the transmitter ID in the PHY control field of the physical layer packet;
- set the Short RD ID of RD_2 as the receiver address of the frame in the PHY control field;
- includes Long RD ID of RD_2, received from the association request to, and its own Long RD ID into, the Unicast Header (see clause 6.3.3.3), of the MAC PDU of the physical layer packet;
- include a set of association parameters on how the communication may continue;
- if the association request was ciphered and integrity protected, RD_2 uses ciphering and integrity protection to the MAC PDU.

If RD_2 cannot accept the association, it sends an Association Response as above with cause and timer *rejectTime* to inform the association request is rejected to RD_1.

When RD_1 receives Association Response:

- if the association request is accepted and RD-1 can operate with provided configuration in the association response:
 - start using the provided configuration and consider the association successful;
 - procedure ends;
- else if RD-1 cannot operate with provided configuration in association response:
 - send association release as defined in clause 5.8.6;
- if the association response is rejected:
 - RD-1 shall consider association failed;
 - RD-1 shall prohibit sending a new association request to RD-2 until timer *rejectTime* is expired;
 - RD-1 should initiate RD selection for the association procedure as defined in clause 5.1.4.

5.8.6 Association Release

When an RD wants to release an association with another RD, the RD sends an Association Release message. The RD can send the Association Release at any time. When the physical layer confirms the transmission of MAC PDU containing Association Release message, the RD shall:

- consider association as released;
- clear all configurations, buffers and timers regarding this association.

When an RD receives Association Release Message from another RD, the RD shall:

- consider association as released;
- clear all configurations, buffers and timers regarding this association.

5.9 Security Procedures

5.9.1 Mode 1

5.9.1.1 General

Mode 1 uses AES-128 for ciphering with integrity protection to provide confidentiality and message authentication of a MAC PDU as defined in FIPS PUB 197 [4].

For Mode 1 the RD shall have two keys, one for integrity protection and another for encryption.

Mode 1 uses secret keys for both ciphering and integrity protection. The method is transparent for the method used for RD authentication and key distribution.

Both the integrity and encryption process is initiated by the RD when receiving a MAC PDU that contains the MAC security Info IE, clause 6.4.3.1. The security Info IE is used to synchronize the initialization vector between two RDs. The security Info IE can be received in a beacon message or from unicast MAC PDU.

5.9.1.2 Integrity protection

The Mode 1 integrity protection of the messages is obtained by using the message integrity code (MIC) that is added to the end of the MAC PDU as shown in Figure 6.3.1-1. The MIC shall be calculated by using the CMAC (OMAC-1) message authentication algorithm with AES-128 as an underlying symmetric key block cipher as defined in NIST Special Publication 800-38B [5].

When an RD is transmitting the MAC PDU and Mode 1 security is applied, the RD shall:

- construct the MAC PDU, including MAC header type, MAC common header, and add all MAC SDUs by using the MAC mux header into the MAC PDU;
- generate a MIC from the complete MAC PDU;
- truncate the MIC to 5 octets and amend it to the end of MAC PDU;
- take actions defined in clause 5.9.1.3 for ciphering the data.

When an RD has received a MAC PDU that indicates in the MAC header that security is applied the RD shall:

- verify the received MIC:
 - if the MIC is correct:
 - process the MAC PDU further;
 - else:
 - discard the complete MAC PDU.

5.9.1.3 Ciphering

Mode 1 uses AES-128 counter mode (CTR) for encryption as defined in FIPS PUB 197 [4]. The initialization vector (IV) for the counter is defined in Table 5.9.1.3-1. The bit 0 is the most significant bit and bit 127 is the least significant bit of the initialization vector.

Table 5.9.1.3-1: Initialization vector

Bits	Definition
0 to 31 (octets: 0 to 3)	Long RD-ID of the transmitter.
32 to 63 (octets: 4 to 7)	Long RD ID of the receiver.
64 to 95 (octets: 8 to 11)	Hyper Packet Counter (HPC).
96 to 107	Packet Sequence Number (PSN), transmitted in MAC PDU. Set to zero when a MAC PDU packet contains one time HPC.
108 to 127	Ciphering engine internal byte counter. Increased by one at every 16 byte ciphered block. Set to zero for the first 16 byte block of the MAC PDU.

When RD is transmitting the MAC PDU, and Mode 1 security is applied, the RD shall:

- if the MAC PDU is transmitted with a DATA MAC PDU header or Unicast Header:
 - if the MAC PDU sequence number is 0;
 - increment the HPC by one;
 - use the MAC PDU sequence number as the PSN;
 - if the RD is sending one or multiple MAC IEs as plain text:
 - indicate the presence of a Security info IE in MAC Header Type;
 - cipher the MAC PDU from the Security info IE onwards including the MIC;
 - else if the RD is initiating security or re-synchronizing the HPC:
 - increase the HPC at least by one from the previously used value and include a Security info IE into the MAC PDU;
 - indicate the presence of the Security info IE in the MAC Header Type and set the Security IV type to resynchronizing the HPC;

- cipher the MAC PDU from the Security info IE onwards including the MIC;
- else if the RD is detecting an IV synchronization error, and is not able to send re-synchronizing the HPC:
 - increase the HPC at least by one from the previously used value and include a Security info IE into the MAC PDU;
 - indicate the presence of the Security info IE in the MAC header type and set the Security IV type to One time HPC with HPC request;
 - cipher the MAC PDU from the Security info IE onwards including the MIC;
- else:
 - indicate that the MAC security is applied in the MAC Header Type;
 - cipher the MAC PDU from the MAC Common header onwards including MIC;
- procedure ends;
- else if the MAC PDU is transmitted with a Beacon header, or an RD Broadcasting Header:
 - increment the HPC by at least one from the previously used value;
 - set the PSN to zero;
 - if the RD is initiating or re-synchronizing the HPC:
 - set the Security IV type to resynchronizing HPC;
 - include a Security info IE with HPC into the MAC PDU;
 - indicate the presence of the Security info IE in the MAC header type;
 - cipher MAC PDU from the Security info IE onwards including MIC;
 - procedure ends.

When the RD is receiving the MAC PDU, and Mode 1 security is applied, the RD shall:

- if the MAC PDU is received with DATA MAC PDU header or Unicast Header:
 - if MAC PDU sequence number is 0;
 - increment the HPC by one;
 - use the MAC PDU sequence number as the PSN;
 - if the Security info IE is present in the MAC Header Type and Security IV type is set to initiating security or resynchronizing HPC:
 - obtain the HPC from the Security info;
 - use the obtained HPC for receiving and transmitting future MAC PDUs;
 - decipher the MAC PDU from the Security info IE onwards including the MIC using the HPC and the PSN;
 - else if the Security info IE is present in the MAC header type:
 - decipher the MAC PDU from the Security info IE onwards including the MIC;
 - else:
 - decipher the MAC PDU from the MAC Common header onwards including the MIC;
 - take actions defined in clause 5.9.1.2;

- if the MAC PDU is received with Beacon header, or RD Broadcasting Header:
 - set the PSN to zero;
 - obtain the HPC from the Security info;
 - if is set to Security IV type to resynchronizing HPC:
 - use the obtained HPC for receiving and transmitting future MAC PDUs;
 - decipher the MAC PDU from the Security info IE onwards including the MIC using the HPC and the PSN;
 - take actions defined in clause 5.9.1.2.

5.10 Reconfiguration

When an RD receives a reconfiguration request message the RD shall:

- consider the received configuration and whether it can support it;
- if the RD can support the configuration the RD shall:
 - send a reconfiguration response message indicating that the configuration is accepted;
 - consider the new configuration to be valid after the physical layer confirms that the reconfiguration response has been sent;
- if the RD cannot support the received configuration the RD shall:
 - send a reconfiguration response message including a configuration that it can support;
 - consider the new configuration to be valid after the physical layer confirms that the reconfiguration response has been sent.

When an RD receives the reconfiguration response message the RD shall:

- if the reconfiguration response message indicates that the configuration included in reconfiguration request message is completely accepted:
 - consider the new configuration to be valid immediately;
- if the reconfiguration response message contains new configuration parameters:
 - if the RD can support configuration from the received reconfiguration response:
 - consider the new configuration to be valid immediately;
 - else:
 - initiate transmission of an association release message with a release cause "incompatible configuration".

6 Protocol Data Units, formats and parameters

6.1 General

MAC protocol has two separate parts in the physical layer packet for transmitting and receiving information. The first part is the Physical Header Field, clause 6.2 and the second part is the MAC PDU, clause 6.3.

Both the Physical Header Field and the MAC PDU are bit strings that are byte aligned (i.e. a multiple of 8 bits) in length. In figures and tables in clause 6, bit strings are represented as the most significant bit in the leftmost bit of the first line of the table, the least significant bit is the rightmost bit on the last line of the table, and more generally the bit string is to be read from left to right and then in the reading order of the lines. The bit order of each parameter field within a Physical Header Field and a MAC PDU is represented with the first and most significant bit in the leftmost bit and the last and least significant bit in the rightmost bit.

6.2 Physical Header Field

6.2.1 General

In a packet transmission the MAC layer defines the number of antennas used for transmission, the transmission format of the physical layer packet and sets the content of the physical layer control field. The physical layer supports two (2) different sizes of the physical layer control field. Different sizes are:

- Type 1: 40 bits.
- Type 2: 80 bits.

The information coding for each type is as defined in Tables 6.2.1-1, 6.2.1-2 and 6.2.1-2a and presented in Figure 6.2.1-1 and Figure 6.2.1-2.

The physical layer amends the content with 16-bit CRC and performs the physical layer transmission procedure as defined in ETSI TS 103 636-3 [3].

Table 6.2.1-1: Physical Layer Control Field: Type 1, Header Format: 000

Control channel field	#bits	Explanation
Header Format	3	Defines the format of the control header Type 1. Bits are set to 000.
Packet length type	1	Indicates whether the transmission length is indicated in subslots or slots: If set to 0, the length is given in subslots. If set to 1 the length is given in slots.
Packet length	4	The length of the packet transmission in subslot or slots. The packet length is a signalled numerical value plus one subslot or slot. The length of the subslot is 5 OFDM symbols as defined in ETSI TS 103 636-3 [3].
Short Network ID	8	Short network ID of the RD as defined in clause 4.2.3.1.
Transmitter Identity	16	Short RD ID of the RD as defined in clause 4.2.3.3.
Transmit Power	4	Defines the used TX power as defined in Table 6.2.1-3a.
Reserved	1	Reserved. Set to zero by the transmitter. The Receiver shall ignore this bit.
DF MCS	3	Defines the MCS of the transmission as defined in ETSI TS 103 636-3 [3].

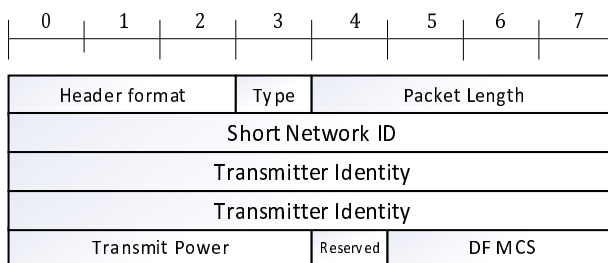

Figure 6.2.1-1: Physical Layer Control Field: Type 1

Table 6.2.1-2: Physical Layer Control Field: Type 2, Header Format: 000

Control channel field	#bits	Explanation
Header Format	3	Defines the format of the control header Type 2. Bits are set to 000.
Packet length type	1	Indicates whether the transmission length is indicated in subslots or slots: If set to 0, the length is given in subslots. If set to 1 the length is given in slots.
Packet length	4	The length of the packet transmission in subslot or slots. The packet length is a signalled numerical value plus one subslot or slot. The length of the subslot is 5 OFDM symbols as defined in ETSI TS 103 636-3 [3].
Short Network ID	8	Short network ID of the RD as defined in clause 4.2.3.1.
Transmitter Identity	16	Short RD ID of the RD as defined in clause 4.2.3.3.
Transmit Power	4	Defines the used TX power as defined in Table 6.2.1-3a.
DF MCS	4	Defines the MCS of the transmission as defined in ETSI TS 103 636-3 [3].
Receiver Identity	16	Short RD ID of the receiving RD, or broadcast ID as defined in clause 4.2.3.3.
Number of Spatial Streams	2	Number of spatial streams of the data field as defined in Table 6.2.1-4.
DF Redundancy Version	2	Defines the redundancy version number of the transmission as defined in clause 6.1.5.3 of ETSI TS 103 636-3 [3].
DF New data Indication	1	The transmitter toggles this bit to control whether the receiver combines this transmission with the previous content of the HARQ process.
DF HARQ Process Number	3	HARQ process number of this transmission.
Feedback format	4	Defines the coding of the feedback info as defined in Table 6.2.2-1.
Feedback info	12	Feedback information in clause 6.2.2.

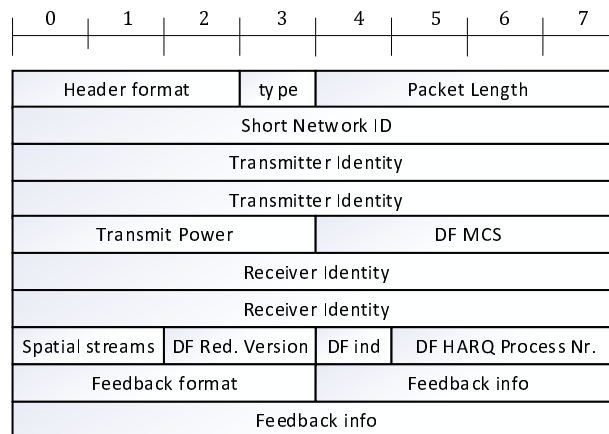

Figure 6.2.1-2: Physical Layer Control Field: Type 2

Table 6.2.1-2a: Physical Layer Control Field: Type 2, Header Format: 001

Control channel field	#bits	Explanation
Header Format	3	Defines the format of the control header Type 2. Bits are set to 001. Indicating that the transmitter does not request HARQ feedback for the DF of this packet.
Packet length type	1	Indicates whether the transmission length is indicated in subslots or slots: If set to 0, the length is given in subslots. If set to 1 the length is given in slots.
Packet length	4	The length of the packet transmission in subslot or slots. The packet length is signalled numerical value plus one subslot or slot. The length of the subslot is 5 OFDM symbols as defined in ETSI TS 103 636-3 [3].
Short Network ID	8	Short network ID of the RD as defined in clause 4.2.3.1.
Transmitter Identity	16	Short RD ID of the RD as defined in clause 4.2.3.3.
Transmit Power	4	Defines the used TX power as defined in Table 6.2.1-3a.
DF MCS	4	Defines the MCS of the transmission as defined in ETSI TS 103 636-3 [3].
Receiver Identity	16	Short RD ID of the receiving RD, or broadcast ID as defined in clause 4.2.3.3.
Number of Spatial Streams	2	Number of spatial streams of the data field as defined in Table 6.2.1-4.
Reserved	6	Reserved. Set to zero by the transmitter. The receiver shall ignore these bits.
Feedback format	4	Defines the coding of the feedback info as defined in Table 6.2.2-1.
Feedback info	12	Feedback information in clause 6.2.2.
NOTE: When packet transmission is done with this version of the Physical Layer Control Field: Type 2 the DF Redundancy Version is set to 0.		

Table 6.2.1-3a: Transmit Power

Bit field	TX Power [dBm]
0000	-40
0001	-30
0010	-20
0011	-13
0100	-6
0101	-3
0110	0
0111	3
1000	6
1001	10
1010	14
1011	19
1100	23
1101	26
1110	29
1111	> 32

Table 6.2.1-3b: Transmit Power

Bit field	TX Power [dBm]
0000	reserved
0001	reserved
0010	reserved
0011	-13
0100	-6
0101	-3
0110	0
0111	3
1000	6
1001	10
1010	14
1011	19
1100	23
1101	26
1110	29
1111	> 32

Table 6.2.1-4: Number of Spatial Streams

Bit field	Transmission mode
00	Single spatial stream
01	Two spatial streams
10	Four spatial streams
11	Eight Spatial streams

6.2.2 Coding of Feedback info

The coding of the feedback info is indicated with the Feedback format field in Table 6.2.2-1.

Table 6.2.2-1: Feedback format for 12-bit Feedback Info

Bit field	Feedback format
0000	No feedback. Receiver shall ignore feedback info bits
0001	Format 1, Table 6.2.2-2a
0010	Format 2, Table 6.2.2-2b
0011	Format 3, Table 6.2.2-2c
0100	Format 4, Table 6.2.2-2d
0101	Format 5, Table 6.2.2-2e
0110 to 1110	Reserved
1111	Escape

Table 6.2.2-2a: Feedback info format 1

Field	#bits	Explanation
HARQ Process number	3	Indicates the process of the HARQ feedback.
Transmission feedback	1	If set to 0, the feedback is a Negative Acknowledgement (NACK). If set to 1 the feedback is a positive Acknowledgement (ACK).
Buffer Status	4	Buffer status, as defined in Table 6.2.2-4.
Channel Quality Indicator (CQI)	4	Channel quality indicator, as defined in Table 6.2.2-3.

Table 6.2.2-2b: Feedback info format 2

Field	#bits	Explanation
Codebook index	3	Codebook index as defined in Table 6.3.4-1 for a single layer, or Table 6.3.4-3 for a dual layer as defined in ETSI TS 103 636-3 [3].
MIMO Feedback	1	Bit coding: 0: Single layer. 1: Dual layers.
Buffer Status	4	Buffer status, as defined in Table 6.2.2-4.
Channel Quality Indicator (CQI)	4	Channel quality indicator, as defined in Table 6.2.2-3.

Table 6.2.2-2c: Feedback info format 3

Field	#bits	Explanation
HARQ Process number	3	Indicates the process of the HARQ feedback.
Transmission feedback	1	If set to 0, the feedback is a Negative Acknowledgement (NACK). If set to 1 the feedback is a positive Acknowledgement (ACK).
HARQ Process number	3	Indicates the process of the HARQ feedback.
Transmission feedback	1	If set to 0, the feedback is a Negative Acknowledgement (NACK). If set to 1 the feedback is a positive Acknowledgement (ACK).
Channel Quality Indicator (CQI)	4	Channel quality indicator, as defined in Table 6.2.2-3.

Table 6.2.2-2d: Feedback info format 4

Field	#bits	Explanation
HARQ feedback bitmap	8	HARQ feedback bitmap, where the bit position indicates the process number. 1 st bit is for process 0, and the 8 th bit is for process 7. A process where data has been successfully decoded and ACK has not sent is set to 1. Otherwise, the bit is set to 0.
Channel Quality Indicator (CQI)	4	Channel quality indicator, as defined in Table 6.2.2-3.

Table 6.2.2-2e: Feedback info format 5

Field	#bits	Explanation
HARQ Process number	3	Indicates the process of the HARQ feedback.
Transmission feedback	1	If set to 0, the feedback is a Negative Acknowledgement (NACK). If set to 1 the feedback is a positive Acknowledgement (ACK).
MIMO Feedback	2	Bit coding: 00: Single layer, codebook index included. 01: Dual layers, codebook index included. 10: Four layers, codebook index included. 11: Reserved.
Codebook index	6	Codebook index as defined in Table 6.3.4-2 for single layer, or Table 6.3.4-4 for dual layers or Table 6.3.4-5 for four layers, as defined in ETSI TS 103 636-3 [3].

The coding of the Channel Quality Indicator (CQI) is presented in Table 6.2.2-3. The RD shall select the index in such a manner that the BLER does not exceed 10 % with the indicated MCS in the given channel conditions. The MCS values are defined in Annex A of ETSI TS 103 636-3 [3]. The index out of range is indicated even when decoding of MCS-0 is not possible with a 10 % BLER.

Table 6.2.2-3: Channel Quality Indicator

Bit field	Modulation
0000	Out of Range
0001	MCS-0
0010	MCS-1
0011	MCS-2
0100	MCS-3
0101	MCS-4
0110	MCS-5
0111	MCS-6
1000	MCS-7
1001	MCS-8
1010	MCS-9
1011	MCS-10
1100	MCS-11
1101 to 1111	Reserved

The coding of the buffer status is presented in Table 6.2.2-4. When included in the feedback info, the RD shall report the remaining available data in its MAC buffer after the MAC PDU is included in the data field indicated in this physical header field.

Table 6.2.2-4: Buffer Status

Bit field	Buffer Size (BS) value [bytes]
0000	BS = 0
0001	$0 < BS \leq 16$
0010	$16 < BS \leq 32$
0011	$32 < BS \leq 64$
0100	$64 < BS \leq 128$
0101	$128 < BS \leq 256$
0110	$256 < BS \leq 512$
0111	$512 < BS \leq 1\ 024$
1000	$2\ 048 < BS \leq 4\ 096$
1001	$4\ 096 < BS \leq 8\ 192$
1010	$8\ 192 < BS \leq 16\ 384$
1011	$16\ 384 < BS \leq 32\ 768$
1100	$32\ 768 < BS \leq 65\ 536$
1101	$65\ 536 < BS \leq 131\ 072$
1110	$131\ 072 < BS \leq 262\ 144$
1111	$BS > 262\ 144$

6.3 MAC PDU

6.3.1 General

The basic MAC PDU structure is depicted in Figure 6.3.1-1 presenting also parts of the MAC PDU that are ciphered and are covered by integrity protection if the MAC layer security is used. The MAC PDU contains the following parts:

- MAC header type, clause 6.3.2;
- MAC Common header, clause 6.3.3;
- one or more MAC SDU that is included in MAC PDU with MAC multiplexing header, clause 6.3.4;
- Message Integrity Code MIC, clause 5.9.1.

The first byte of the MAC PDU is the MAC header type in Figure 6.3.1-1, and the first bit of the MAC Header type is the bit zero in Figure 6.3.2-1.

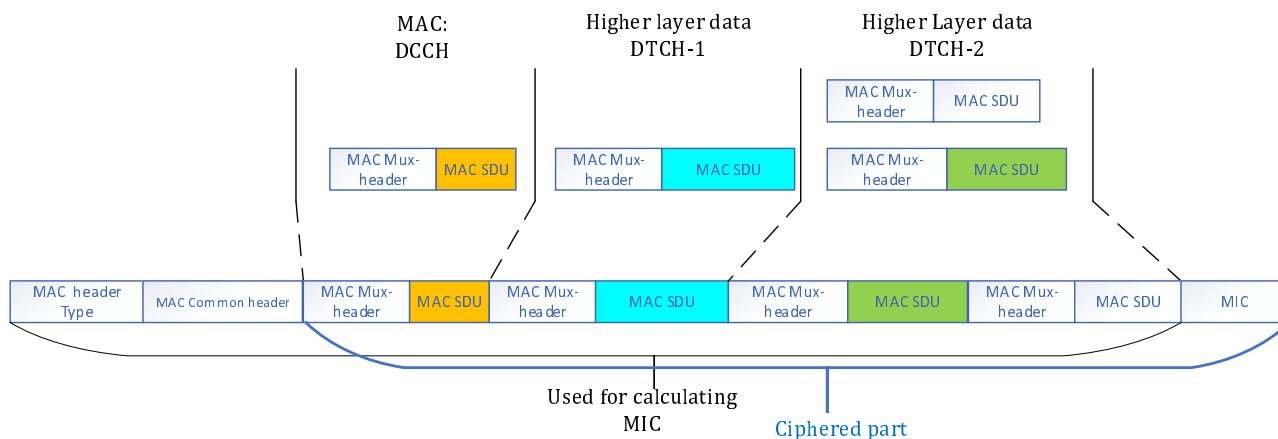

Figure 6.3.1-1: MAC PDU: MAC multiplexing with security ciphering and integrity protection

The MAC PDU always follows this general format for all transport channels (PCH/BCH, DCH, or RACH).

6.3.2 MAC Header type

The MAC header type field has a length of a single octet. The bits of the octet are defined as shown in Figure 6.3.2-1. The version bits shall be set to 00. The MAC security info is defined in Table 6.3.2-1. The MAC header type field is defined in Table 6.3.2-2.



Figure 6.3.2-1: MAC header Type

Table 6.3.2-1: MAC Security

Value	Definition
00	MAC security is not used for this MAC PDU.
01	MAC security is used and the MAC Security IE is not present. The MAC PDU sequence number is used as PSN for security. The ciphred part starts immediately after the MAC Common header.
10	MAC is security used and a MAC Security Info IE is in the MAC PDU. The ciphred part starts immediately after the MAC Security info.
11	Reserved.

Table 6.3.2-2: MAC header Type field

Value	Definition
0000	DATA MAC PDU header as defined in Figure 6.3.3.1-1
0001	Beacon Header as defined in Figure 6.3.3.2-1
0010	Unicast Header as defined in Figure 6.3.3.3-1
0011	RD Broadcasting Header as defined in Figure 6.3.3.4-1
1111	Escape

After the MAC header type field, the MAC Common header is included.

6.3.3 MAC Common header

6.3.3.1 DATA MAC PDU header

The DATA MAC PDU header, MAC Common header, has a single 12-bit sequence number as shown in Figure 6.3.3.1-1. The receiver may perform duplicate detection and packet re-ordering after HARQ re-transmission based on the sequence number. When the reset bit is set to 1, the receiver shall consider this PDU as the first PDU in MAC for the re-ordering function.

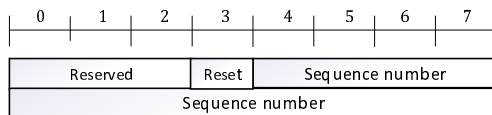

Figure 6.3.3.1-1: DATA MAC PDU

6.3.3.2 Beacon Header

The Beacon Header, MAC Common header, has the first 24 MSB of the Network ID in the first 3 octets, followed by 4 octets for the Transmitter Address as shown in Figure 6.3.3.2-1. The RD sets the Transmitter Address to its own Long RD ID when transmitting the Beacon header.

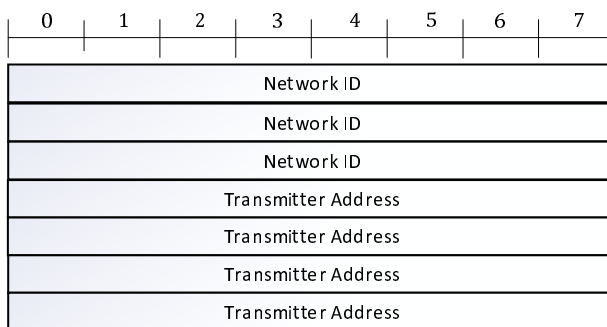

Figure 6.3.3.2-1: Beacon Header

6.3.3.3 Unicast Header

The Unicast Header, MAC Common header, has a single 12-bit sequence number as the first octet. The receiver may perform duplicate detection and packet re-ordering after HARQ re-transmission based on the sequence number. When the reset bit is set to 1, the receiver shall consider this PDU as the first PDU in the MAC re-ordering function.

The next 4 octets are the Receiver Address, followed by 4 octets of the Transmitter Address as shown in Figure 6.3.3.3-1. The RD sets the Receiver Address to the targeted receiver's Long RD ID value and sets the Transmitter Address to its own Long RD ID when transmitting the Unicast header. The header type provides an association between the 16 bit Short RD ID and the Long RD ID.

The RD shall use this header type for:

- association signalling defined in clause 5.8;
- association signalling due to mobility;
- re-establishment of the connection after being out of service;
- re-synchronizing MAC security.

The RD may use this header type for any user plane packet if the transmitter of the MAC PDU desires to include the full address in the MAC PDU.

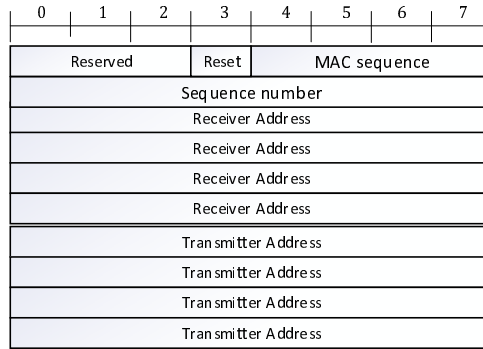

Figure 6.3.3.3-1: Unicast Header

6.3.3.4 RD Broadcasting Header

The RD Broadcasting Header, MAC Common header, has single a 12-bit sequence number as the first octet. The receiver may perform reordering and duplicate detection based on the sequence number. When the reset bit is set to 1, the receiver shall consider this PDU as the first PDU in the MAC re-ordering function.

The next 4 octets are the Transmitter Address as shown in Figure 6.3.3.4-1.

The RD sets the Transmitter Address to its own Long RD ID when transmitting the RD Broadcasting header.

The RD shall use this header type for:

- broadcast user plane messages to all other RDs in the same network without previous association or reception of a beacon with the Long RD ID.

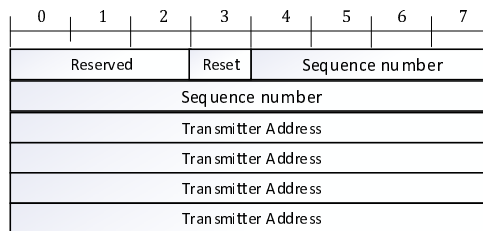

Figure 6.3.3.4-1: RD Broadcasting Header

6.3.4 MAC multiplexing header

MAC multiplexes multiple MAC SDUs into a single MAC PDU by adding the MAC Multiplexing header (MAC Mux header) into the MAC SDU. The header includes one octet of information, with two fields: MAC Extension (MAC_Ext) and the IE Type, and an optional one or two octet length field. The length field indicates the length of the MAC SDU in octets. An 8 bit length can indicate an SDU length between 0 and 255 octets and a 16 bit length can indicate an SDU length between 0 and 65 535 octets.

Different MAC MUX-header options are shown in Figure 6.3.4-1.

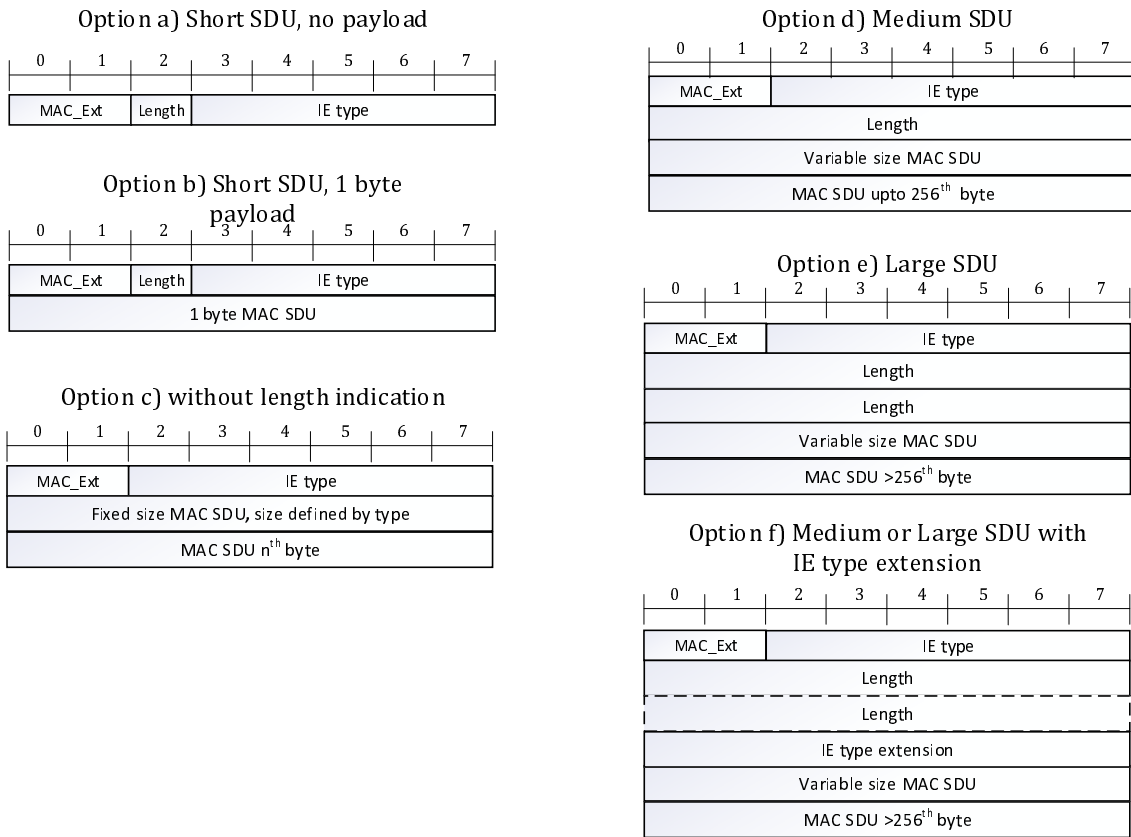

Figure 6.3.4-1: MAC multiplexing PDU with different header options

Table 6.3.4-1: MAC extension field encoding

Value	Definition
00	No length field is included in the IE header. The IE type defines the length of the IE payload.
01	8 bit length included indicating the length of the IE payload.
10	16 bit length included indicating the length of the IE payload.
11	Short IE, a one bit length field is included in the IE header. The IE payload size is 0 bytes when the length bit (bit 2) is set to 0, or 1 byte when the length bit (bit 2) is set to 1, shown in Figure 6.3.4-1 option a) and option b).

The IE type field indicates the content type of the MAC SDU as defined in Table 6.3.4-2. The code point 111110 is reserved for proprietary extensions and code point 111111 is for future extensions.

Table 6.3.4-2: IE type field encoding for MAC Extension field encoding 00, 01, 10

Value	Definition
000000	Padding IE
000001	Higher layer signalling - flow 1
000010	Higher layer signalling - flow 2
000011	User plane data - flow 1
000100	User plane data - flow 2
000101	User plane data - flow 3
000110	User plane data - flow 4
000111	Reserved
001000	Network Beacon message
001001	Cluster Beacon message
001010	Association Request message
001011	Association Response message
001100	Association Release message
001101	Reconfiguration Request message
001110	Reconfiguration Response message
001111	Additional MAC messages
010000	Security Info IE
010001	Route Info IE
010010	Resource allocation IE
010011	Random Access Resource IE
010100	RD capability IE
010101	Neighbouring IE
010110	Broadcast Indication IE
010111	Group Assignment IE
011000	Load Info IE
011001	Measurement Report IE
011010 to 111101	Reserved
111110	Escape
111111	IE type extension. There is an additional 1 byte IE type extension field after a one or two byte length field. The length includes the length of the payload and the extension

For the MAC extension field encoding 11 and a payload length of 0, the IE types are defined in Table 6.3.4-3. The code point 11110 is reserved for proprietary extensions. The actual IE content does not exist as it has zero length.

Table 6.3.4-3: IE type field encoding for MAC extension field encoding 11 and payload length 0 byte

Value	Definition
00000	Padding IE
00001	Configuration Request IE
00010 to 01111	Reserved
10000	Security Info IE
10001 to 11101	Reserved
11110	Escape
11111	Reserved

For the MAC extension field encoding 11 and a payload length of 1 byte, the IE types are defined in Table 6.3.4-4. The code point 11110 is reserved for proprietary extensions.

Table 6.3.4-4: IE type field encoding for MAC extension field encoding 11 and payload length of 1 byte

Value	Definition
00000	Padding IE
00001	Radio Device Status IE
00010 to 11101	Reserved
11110	Escape
11111	Reserved

6.4 MAC Messages and Information Elements (IEs)

6.4.1 General

The following clauses present the content of the different MAC messages and MAC information elements IEs. Only the content of each IE is presented without the MAC multiplexing header.

A MAC IE can be multiplexed with MAC messages, other MAC IEs or with a MAC SDU containing higher layer signalling or user plane data flow in a single MAC PDU. The receiver may process all the received MAC messages or MAC IEs received in a single MAC PDU in any order.

The bit coding for fields with multiple possible values shall follow the coding where the first listed value is coded as all zeros and the next value is coded as value 1, and so on.

EXAMPLE: If the given values are: 50 ms, 100 ms, 500 ms, 1 000 ms, and the bitfield size is 2 bits, values would be coded to bits as: 00: 50 ms, 01: 100 ms, 10: 500 ms and 11: 1 000 ms.

All fields or bits or code values marked as reserved in any IE are reserved for future use. The receiver shall ignore these fields or bits. The transmitter shall set the reserved bits or bits in reserved fields to zero. If the receiver receives a field with a code value that is reserved, it shall consider that the IE is incorrect and not act on this IE.

6.4.2 MAC messages

6.4.2.1 General

The following clauses present the content of the different MAC messages.

6.4.2.2 Network Beacon message

The network beacon message is used to announce the presence of a network and indicate the cluster beacon transmission timing, periodicity, and operating channel.

The network beacon is always transmitted with a Beacon Header, clause 6.3.3.2, and if the MAC security is applied to the network beacon the MAC Security Info IE, clause 6.4.3.1, is present.

The Network beacon message contains always the information presented in Figure 6.4.2.2-1 and defined in Table 6.4.2.2-1. The network beacon message may be followed by other optional IEs.

When operating in Mesh mode the RD shall include route info IE, clause 6.4.3.2, and optionally load info IE, clause 6.4.3.10, into the Network beacon message.

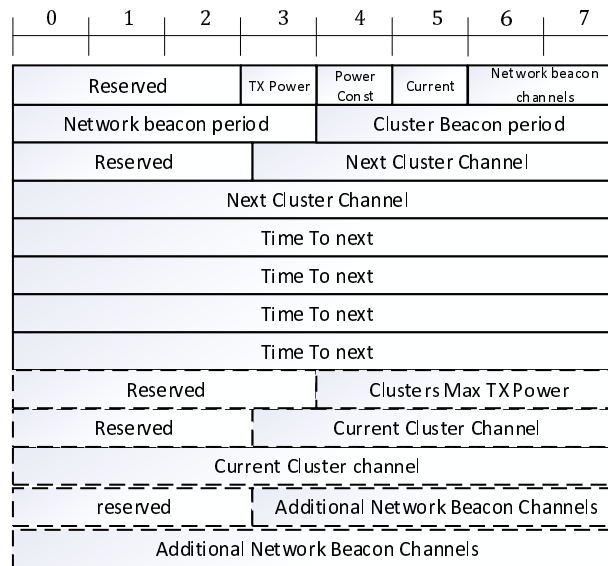

Figure 6.4.2.2-1: Network Beacon Message IE

Table 6.4.2.2-1: Network beacon IE field definitions

Field	Bits	Definition
TX power	1	0: Clusters Max TX power field is not included. 1: Clusters Max TX power field is included.
Power const	1	0: The RD operating in FT mode does not have power constraints. 1: The RD operating in FT mode has power constraints.
Current	1	0: The current cluster channel is the same as the next cluster channel. The current cluster channel field is not included. 1: The current cluster channel is the not same as the next cluster channel. The current cluster channel field is included.
Network Beacon channels	2	Number of additional Network beacon channels included in the end of the network beacon IE. The RD should also scan these channels to detect possible other RDs.
Network Beacon period	4	Indicates the network beacon period in ms. Coded values: 50 ms, 100 ms, 500 ms, 1 000 ms, 1 500 ms, 2 000 ms, 4 000 ms. Rest are reserved.
Cluster Beacon period	4	Indicates the Cluster beacon transmission period in ms. Coded values: 10 ms, 50 ms, 100 ms, 500 ms, 1 000 ms, 1 500 ms, 2 000 ms, 4 000 ms, 8 000 ms, 16 000 ms, 32 000 ms. Rest are reserved.
Next Cluster Channel	13	Operating channel of the cluster for the next cluster beacon period. The field gives the absolute carrier centre frequency as defined in ETSI TS 103 636-2 [2].
Time to Next	32	Time in microseconds until the next beacon period starts.
Clusters Max TX Power	4	Maximum TX power allowed to be used in this cluster for unicast transmissions as coded in Table 6.2.1-3b.
Current cluster channel	13	Operating channel of the cluster for the current cluster beacon period. This field gives the absolute carrier centre frequency as defined in ETSI TS 103 636-2 [2].
Additional Network Beacon Channels	13	Additional network channel(s) of the network to detect Network Beacon messages. This field gives the absolute carrier centre frequency as defined in ETSI TS 103 636-2 [2].

6.4.2.3 Cluster Beacon message

The Cluster Beacon message is used to provide frame and slot timing for the cluster, announce radio parameters and radio resources so that other RDs may communicate to the RD in FT mode.

When an RD receives the Cluster Beacon message, it considers that transmission of the physical layer packet containing cluster beacon message was initiated at the first symbol of the slot 0 in a radio frame if not indicated by Frame Offset Field. If the Frame Offset is present the RD considers that the frame started indicated number of subslots earlier.

The System Frame Number (SFN) provides the frame count.

When broadcasted, the cluster beacon message is always transmitted with the Beacon Header, clause 6.3.3.2, and if MAC security is applied to the network beacon the MAC Security Info, clause 6.4.3.1, is present.

The cluster beacon message contains always the Cluster Beacon IE presented in Figure 6.4.2.3-1 followed by the Random Access Resource IE. After these IEs other optional Ies may follow.

An RD may use a unicast transmission for transmitting a cluster beacon message to a specific RD, by using Unicast Header, clause 6.3.3.3.

When operating in Mesh mode the RD shall include route info IE, clause 6.4.3.2, and optionally load info IE, clause 6.4.3.10, into the Cluster beacon message.

The coding of the Cluster Beacon IE is defined in Table 6.4.2.3-1.

0	1	2	3	4	5	6	7
SFN							
Reserved		TX Power	Power Const	FO	Next Channel	TimeTo Next	
Network beacon period				Cluster Beacon period			
countToTrigger				RelQuality		MinQuality	
Reserved				Cluster Max TX Power			
Frame Offset							
Reserved				Next Cluster Channel			
Next Cluster Channel							
Time To next							
Time To next							
Time To next							
Time To next							

Figure 6.4.2.3-1: Cluster Beacon Message IE

Table 6.4.2.3-1: Cluster beacon IE field definitions

Field	Bits	Definition
SFN	8	Current System Frame number.
TX power	1	As defined in Table 6.4.2.2-1.
Power const	1	As defined in Table 6.4.2.2-1.
FO	1	0: Frame Offset field is not present. 1: Frame Offset field is not present.
Next Channel	1	0: The cluster channel for the next cluster beacon period is the same as the current cluster channel. The next cluster channel field is not included. 1: The cluster channel for the next cluster beacon period is different as the current cluster channel. The next cluster channel field is included.
TimeToNext	1	0: The next cluster beacon is transmitted based on Cluster beacon period. The Time to next field is not present. 1: The next cluster beacon is transmitted in a time location. The Time to next field is present.
Network Beacon period	4	As defined in Table 6.4.2.2-1.
Cluster Beacon period	4	As defined in Table 6.4.2.2-1.
countToTrigger	4	Provides the COUNT_TO_TRIGGER value for the RD initiated mobility, with the following coding: Coded values: 1 times, 2 times, 3 times, 4 times, 5 times, 6 times, 7 times, 8 times, 16 times, 24 times, 32 times, 40 times, 48 times, 64 times, 128 times, 256 times. Reserved.
RelQuality	2	Provides <i>RELATIVE_QUALITY</i> threshold for the RD initiated mobility. Coded values: 0 dB, 3 dB, 6 dB, 9 dB.
minQuality	2	Provides <i>MIN_QUALITY</i> threshold for the RD's initial FT selection. Coded values: 0 dB, 3 dB, 6 dB, 9 dB.
Clusters Max TX Power	4	As defined in Table 6.4.2.2-1.
Frame Offset	8 or 16	The 8 bit version is used when $\mu \leq 4$, otherwise the 16 bit version is used, ETSI TS 103 636-3 [3]. Indicates how many subslots the cluster beacon is delayed from the start of the frame.
Next Cluster Channel	13	As defined in Table 6.4.2.2-1.
Time to next	32	As defined in Table 6.4.2.2-1.

6.4.2.4 Association Request message

The association request message is used by an RD to initiate communication with another RD as defined in clause 5.8.3.

The association request message is sent on Random access resources and transmitted with a Unicast Header, clause 6.3.3.2, and if MAC security is applied to the network beacon the MAC Security Info, clause 6.4.3.1, is present.

The association request message always contains the information presented in Figure 6.4.2.4-1 and defined in Table 6.4.2.4-1. After the association request the RD includes the RD capability IE in the MAC PDU. After these IEs other optional IEs may follow.

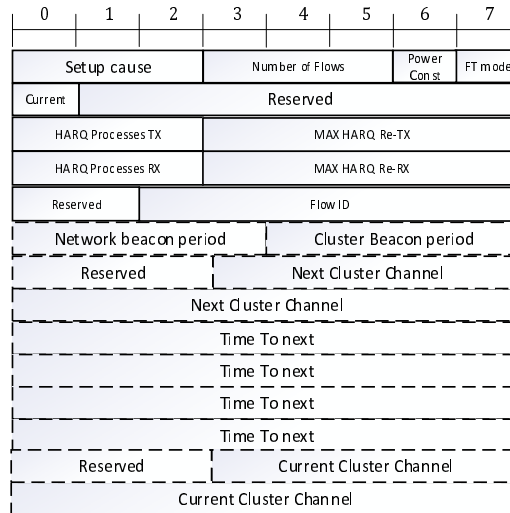

Figure 6.4.2.4-1: Association Request Message IE

Table 6.4.2.4-1: Association Request IE field definitions

Field	Bits	Definition
Setup cause	3	The RD indicates the setup cause of the association as decoded in Table 6.4.2.4-2.
Number of Flows	3	the RD indicates how many different flows it would like to setup. There shall be as many flow IDs included as indicated in this field. Code Value: 111 is reserved and shall not be set.
Power const	1	As defined in Table 6.4.2.2-1.
FT mode	1	0: The RD operates only in PT Mode. 1: The RD operates also in FT mode. RD shall include Network Beacon period, Cluster beacon Period, Next Cluster channel and Time to Next fields.
Current	1	As defined in Table 6.4.2.2-1.
HARQ Process TX MAX HARQ RE-TX	3 5	Number of HARQ processes the RD is requesting to use for its transmission. The maximum HARQ re-transmission delay that the RD use in its transmissions. Coded Values: 0,105 ms, 0,2 ms, 0,4 ms, 0,8 ms, 1 ms, 2 ms, 4 ms, 6 ms, 8 ms, 10 ms, 20 ms, 30 ms, 40 ms, 50 ms, 60 ms, 70 ms, 80 ms, 90 ms, 100 ms, 120 ms, 140 ms, 160 ms, 180 ms, 200 ms, 240 ms, 280 ms, 320 ms, 360 ms, 400 ms, 450 ms, 500 ms, Reserved.
HARQ Process RX MAX HARQ RE-RX	3 5	Number of HARQ processes the RD is requesting to use for its reception. The maximum HARQ re-transmission delay that the RD expects in reception. Coded Values: 0,105 ms, 0,2 ms, 0,4 ms, 0,8 ms, 1 ms, 2 ms, 4 ms, 6 ms, 8 ms, 10 ms, 20 ms, 30 ms, 40 ms, 50 ms, 60 ms, 70 ms, 80 ms, 90 ms, 100 ms, 120 ms, 140 ms, 160 ms, 180 ms, 200 ms, 240 ms, 280 ms, 320 ms, 360 ms, 400 ms, 450 ms, 500 ms, Reserved.
Flow ID	6	ID of the flow to be established, from Table 6.3.4-2.
Network Beacon period	4	As defined in Table 6.4.2.2-1.
Cluster Beacon period	4	As defined in Table 6.4.2.2-1.
Next Cluster Channel	13	As defined in Table 6.4.2.2-1.
Time to next	32	As defined in Table 6.4.2.2-1.
Current Cluster channel	13	As defined in Table 6.4.2.2-1.

Table 6.4.2.4-2: Association Setup Cause IE

Bit coding	Definition
000	Initial association.
001	Association to request new set of flows.
010	Association due to mobility.
011	Re-association after error: Lost of connection, Security error, other error.
100	Change of own operating channel. Only when the RD operates also in FT mode.
101	Change operating mode. Associated originally in PT mode, but started to operate in FT mode, or changed to PT only mode.
110	Other reason.
110 to 111	Reserved.

6.4.2.5 Association Response message

The association response message is used by an RD to accept or reject the association request as defined in clause 5.8.5.

The association response message is transmitted with a Unicast Header, clause 6.3.3.2, and if the MAC security is applied to the network beacon the MAC Security Info, clause 6.4.3.1, is present.

The association response message contains always the first octet of the Association response IE presented in Figure 6.4.2.5-1. The ACK/NACK bit indicates whether the association is accepted or not. If an RD rejects the association request the association response includes only the Reject Cause and rejectTime fields in the second octet.

In case that RD accepts the association request, it indicates Association Response message whether it can support the provided HARQ configuration or it includes a new HARQ configuration it can support. Then RD indicates if it can support all flows or part of the flows that was requested in the association request. If RD can support only part of the flows it includes the flow IDs that it has established.

The Group bit is used to indicate whether the associated RD is associated to the Group with the given Resource Tag. The Group ID and Resource Tag fields are used to indicate pre-allocated resources in group assignment IE.

After the Association Response message, the RD includes the RD capability IE into MAC PDU. After these IEs other optional Ies may follow. The message may include Resource allocation IE enabling scheduled connection between the RDs.

The coding of the Association Response message is defined in Table 6.4.2.5-1.

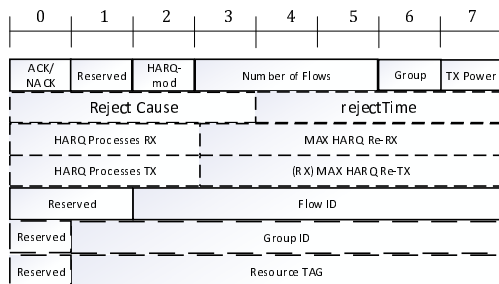

Figure 6.4.2.5-1: Association Response Message IE

Table 6.4.2.5-1: Association Response IE field definitions

Field	Bits	Definition
ACK/NACK	1	0: Association rejected. the reject cause is coded in the second octet of the message, as defined in Table 6.4.2.5-2. Bits 1-7 of the first octet are ignored by the receiver. 1: Association Accepted.
HARQ-mod	1	0: HARQ configuration accepted as configured in the association request. HARQ fields are not present. 1: HARQ configuration present.
Number of flows	3	The RD indicates how many different flows it can accept. There shall be as many flow IDs included as indicated in this field to indicate accepted flow ID. Value Coding: 111, All flows accepted as configured in association request.
Group	1	0: Group ID and Resource Tag are not included. 1: Group ID and Resource Tag are included.
HARQ Process RX	3	Number of HARQ processes the RD is accepting to use for its reception.
MAX HARQ RE-RX	5	The maximum number of HARQ re-transmission the RD expects in reception.
HARQ Process TX	3	Number of HARQ processes the RD is accepting to use for its transmission.
MAX HARQ RE-TX	5	The maximum number of HARQ re-transmission the RD may use in its transmissions.
Flow ID	6	ID of the flow that has been accepted, from Table 6.3.4-2.
Group ID	7	Provides the Group ID for which the resource assignment is valid.
Resource tag	7	Provides the Resource Tag value. The index position of the Resource Tag in RDs resources.

Table 6.4.2.5-2: Reject Cause and rejectTime

Field	Bits	Definition
Reject Cause	4	Cause of the rejection. Coded values: <i>No sufficient radio capacity, No sufficient HW capacity, Conflict with Short-RD ID detected, Non-secured association requests are not accepted, Other reason, Other values are reserved.</i>
Reject Timer	4	Time how long the other RD shall prohibit sending new association requests to this RD. Coded values: 0 s, 5 s, 10 s, 30 s, 60 s, 120 s, 180 s, 300 s, 600 s, other values are reserved.

6.4.2.6 Association Release message

The association release message is used by an RD to release an association with another RD as defined in clause 5.8.6.

The coding of the Association Release message is defined in Figure 6.4.2.6-1 and in Table 6.4.2.6-1.

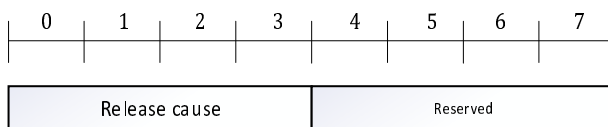

Figure 6.4.2.6-1: Association Release Message IE

Table 6.4.2.6-1: Association Release IE field definitions

Field	Bits	Definition
Release Cause	4	Defines the cause of the association release. Value coding: connection termination, mobility, long Inactivity, incompatible configuration, No sufficient HW/memory resource, No sufficient radio resources, bad radio quality, security error, other error, other reason, reserved.

6.4.2.7 Reconfiguration Request message

The reconfiguration request message is a generic message structure used by an RD to initiate modification of the radio configuration parameters during an existing association.

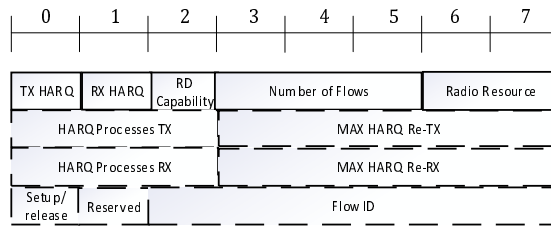

Figure 6.4.2.7-1: Reconfiguration Request Message IE

Table 6.4.2.7-1: Reconfiguration Request IE field definitions

Field	Bits	Definition
TX HARQ	1	0: HARQ TX configuration is not requested to be modified. 1: HARQ TX configuration is requested to be modified. HARQ Process TX and MAX HARQ RE-TX fields are present.
RX HARQ	1	0: HARQ RX configuration is not requested to be modified. 1: HARQ RX configuration is requested to be modified. The HARQ Process RX and MAX HARQ RE-RX fields are present.
RD Capability	1	0: Ignore. 1: The RD capability is changed. The RD capability IE, clause 6.4.3.5, included after the reconfiguration message.
Number of flows	3	The RD indicates how many different flows are requested to be modified. There shall be as many setup/release, flow IDs included as indicated in this field.
Radio Resource	2	Change in radio resources. Value coding: No Change, Requesting More resources, Requesting less resources, The Resource allocation, clause 6.4.3.3, IE is included after the reconfiguration message.
HARQ Process TX	3	As defined in Table 6.4.2.4-1.
MAX HARQ RE-RX	5	As defined in Table 6.4.2.4-1.
HARQ Process TX	3	As defined in Table 6.4.2.4-1.
MAX HARQ RE-TX	5	As defined in Table 6.4.2.4-1.
Setup/Release	1	0: The flow indicated in the Flow ID is for setup or reconfiguration. 1: The flow indicated in the Flow ID is released.
Flow ID	6	As defined in Table 6.4.2.4-1.

6.4.2.8 Reconfiguration Response message

The reconfiguration response message is a response message to the reconfiguration request message, used by an RD to accept radio configuration parameters during an existing association.

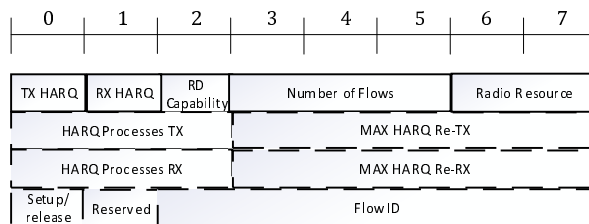

Figure 6.4.2.8-1: Reconfiguration Response Message IE

Table 6.4.2.8-1: Reconfiguration Response IE field definitions

Field	Bits	Definition
TX HARQ	1	0: HARQ TX configuration is accepted or is not modified in the reconfiguration request. 1: HARQ TX configuration is not accepted. HARQ Process TX and MAX HARQ RE-TX fields are present.
RX HARQ	1	0: HARQ RX configuration is accepted or is not modified in reconfiguration request. 1: HARQ RX configuration is not accepted. HARQ Process RX and MAX HARQ RE-RX fields are present.
RD Capability	1	0: Ignore. 1: The RD indicates that its capability is changed. The RD capability IE, clause 6.4.3.5 included after the reconfiguration message.
Number of flows	3	The RD indicates how many different modifications of flows it can accept. The RD shall always accept all releases. There shall be as many flow IDs included as indicated in this field to indicate the accepted flow ID. Value Coding: 111, All flows accepted as configured in the reconfiguration request.
Radio Resource	2	Change in radio resources. Value coding: No Change, Requesting More resources, Requesting less resources, Resource allocation IE, clause 6.4.3.3, included after the reconfiguration message.
HARQ Process TX	3	As defined in Table 6.4.2.4-1.
MAX HARQ RE-RX	5	As defined in Table 6.4.2.4-1.
HARQ Process RX	3	As defined in Table 6.4.2.4-1.
MAX HARQ RE-TX	5	As defined in Table 6.4.2.4-1.
Setup/Release	1	0: The flow indicated in the Flow ID is for setup or reconfiguration. 1: The flow indicated in the Flow ID is released.
Flow ID	6	As defined in Table 6.4.2.4-1.

6.4.2.9 Additional MAC message

This MAC multiplexing header codepoint is reserved for future provisions of different additional MAC messages.

6.4.3 MAC information elements

6.4.3.1 MAC Security Info IE

The MAC security info is presented in Figure 6.4.3.1-1. The version field indicates the security mode as defined in Table 6.4.3.1-1. The key index indicates the currently used key. The transmitter shall indicate an increase of the key index by one when taking a new key in use. The security IV type coding is depending on the security version, and for Mode 1 it is defined in Table 6.4.3.1-2.

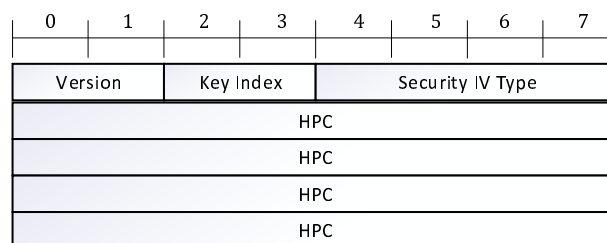
**Figure 6.4.3.1-1: MAC Security Info****Table 6.4.3.1-1: Version**

Value	Definition
00	Mode 1
01	Reserved
10	Reserved
11	Reserved

Table 6.4.3.1-2: Security IV type for Mode 1

Value	Definition
0000	One time HPC.
0001	Resynchronizing HPC. Initiate Mode -1 security by using this HPC value in both uplink and downlink communication.
0010	One time HPC, with HPC request.
0011 to 1111	Reserved.

6.4.3.2 Route Info IE

In mesh system operation RD transmitting beacon(s) includes route info IE with a beacon message. The route info IE contains the following parameters:

- *sink address*;
- *route cost*;
- *Application sequence number*.

Sink address is set to the Long RD ID (32 bits) of the FT (RD having the internet connection), where the routing tree is originally formed.

The calculation of the *route cost* is left to RD implementation, as a detailed calculation can be dependent on multiple factors. However, the route cost shall be set in such a manner that the following rules are full filled:

- *Route cost* is between values 0 and 255 (i.e. 8 bits) where a smaller value means lower cost and the value is linearly increasing.
- *Route cost* is always increased by at least one (1) for each hop in a mesh network.

The *application sequence number* provides an identification sequence number for the network level application data that needs to be distributed in the DL direction to all members of the mesh network. The application sequence number is used by the RD associated to its next hop to identify whether the application data has changed compared to its current application data. If the sequence number is increased the RD requests the application data, from its next hop, i.e. the RD to which it is associated.

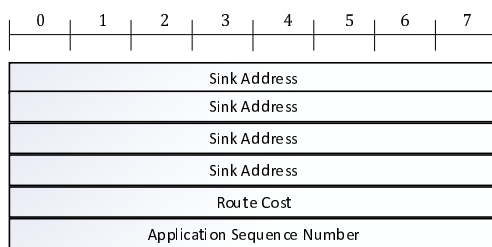

Figure 6.4.3.2-1: Route Info IE

6.4.3.3 Resource allocation IE

The resource allocation IE is used to allocate resources for scheduled transmissions and receptions. The RD operating in FT mode includes this IE in a beacon message or in a unicast message.

The content of the IE is presented in Figure 6.4.3.3-1. The minimum content of the resource allocation IE is 1 octet, when the Allocation Type is set to 00 - release all scheduled resources, otherwise the length of the IE is a minimum of 3 octets. The presence of the optional parts are indicated by the Resource allocation bit map in the first octet. The coding of the bit map is presented in Table 6.4.3.3-1.

0	1	2	3	4	5	6	7
Allocation type		Add	ID	Repeat		SFN	
Channel	RLF	Reserved					
Start subslot							
Start subslot							
Length type	Length						
Start subslot							
Start subslot							
Length type	Length						
Short RD-ID							
Short RD-ID							
Repetition							
Validity							
SFN offset							
reserved			channel				
channel							
reserved			dectScheduledResourceFailure				

Figure 6.4.3.3-1: Resource allocation IE

Table 6.4.3.3-1: Resource allocation bitmap

Field	Value	Definition
Allocation Type	00	The receiving RD shall release all previously allocated scheduled resources. No other fields are present in this IE. Other bits in the bitmap shall be ignored by the RD.
	01	Downlink allocation. The RD receiving this IE shall receive the indicated resources.
	10	Uplink allocation. The RD receiving this IE shall use the indicated resources for transmission.
	11	IE includes both downlink and uplink resources. The first start subslot and length are indicating the DL resources.
Add	0	Resource allocation is new or replaces the previous allocation.
	1	Resource allocation is the additional allocation for existing allocation.
ID	0	Short RD-ID is not present. IE is sent as a unicast message.
	1	Short RD-ID is present. IE is sent in a beacon. Short RD-ID identifies who received the allocation.
Repeat	000	Resource allocation is single allocation and the repetition and validity fields are not present.
	001	Resource allocation is repeated in the following frames with periodicity indicated in the Repetition field, until its validity expires, as indicated in the validity field.
	010	Resource allocation is repeated in the following subslots with periodicity indicated in Repetition field, until its validity expires, as indicated in the validity field.
	011	Resource allocation is repeated in the following frames with periodicity indicated in the Repetition field until its validity expires, as indicated in the validity field. Use of specific repeated resources is allowed after reception of Group ID and assignment Tag from the Group Assignment IE.
	100	Resource allocation is repeated in the following subslots with periodicity indicated in the Repetition field until its validity expires, as indicated in the validity field. Use of specific repeated resources is allowed after reception of Group ID and assignment Tag from the Group Assignment IE.
	101-111	Reserved.
SFN	0	Resource allocation is immediately valid from this frame onwards. The SFN offset field is not present in the IE.
	1	Resource allocation is valid from the frame indicated in SFN offset field onwards.
Channel	0	The resource allocation(s) is valid for the channel where the IE is received. The channel field is not present in the IE.
	1	The channel where resource allocation(s) is valid is indicated in channel field of the IE.
RLF	0	The <i>dectScheduledResourceFailure</i> field is not included. The RD shall use the default value for <i>dectScheduledResourceFailure</i> timer as defined in clause 7.3.
	1	The <i>dectScheduledResourceFailure</i> field is included. The RD shall use the received value for <i>dectScheduledResourceFailure</i> timer.

Start subslot: 8 bits or 16 bits. The start subslot indicates the first subslot where the resource allocation is valid in the frame. The 8 bit version is used when $\mu \leq 4$, otherwise the 16 bit version is used, ETSI TS 103 636-3 [3].

Length type: 1 bit. Indicates whether the length is indicated in subslots or in slots. When set to 0, the length is given in subslots.

Length: 7 bits. The length of the resource allocation in subslots or in slots. The transmitter can split the resource allocation to multiple physical layer packet transmissions.

Repetition: 8 bits. Indicates the repetition of the resource allocation in frames or in subslots. The value 0x0 is not defined and the value 0x1 indicates the next radio frame or subslot.

SFN offset: 8 bits. Indicates the SFN value when the resource allocation is valid.

Validity: 8 bits. Indicates how long the resource allocation is valid in frames. The value 0xFF indicates that the allocation is permanent and valid until explicitly removed.

Channel: 13 bits. Indicates the absolute carrier centre frequency as defined in ETSI TS 103 636-2 [2].

dectScheduledResourceFailure: 4 bits. Indicates the value of *dectScheduledResourceFailure* timer used for the scheduled access data transfer. The coding of the value is defined in Table 6.4.3.3-2.

Table 6.4.3.3-2: Timer dectScheduledResourceFailure values

Bit field	time [ms]
0000	Reserved
0001	Reserved
0010	20
0011	50
0100	100
0101	200
0110	500
0111	1 000
1000	1 500
1001	3 000
1010	4 000
1011	5 000
1100 to 1111	Reserved

6.4.3.4 Random Access Resource IE

The random access resource IE is used to allocate resources for random access transmission and provide the necessary configuration to operate on random access resources. The RACH resource IE has 5 octets of mandatory content.

The presence of each optional field is indicated by the RACH Resource allocation bit map in the first octet. The coding of the bitmap is presented in Table 6.4.3.4-1.

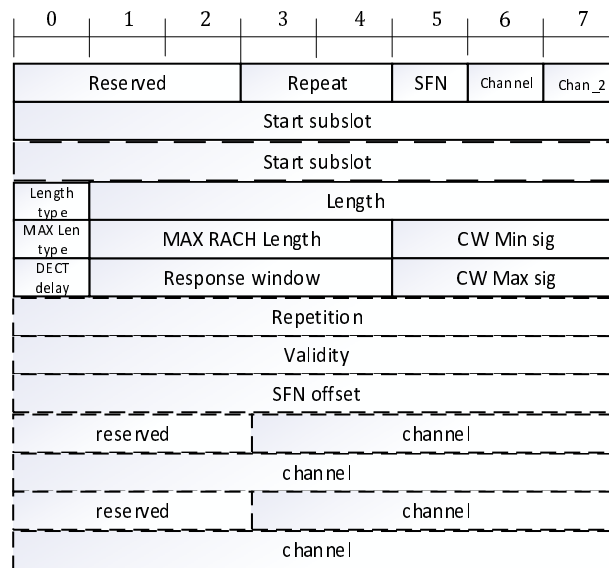

Figure 6.4.3.4-1: Random Access Resource IE

Table 6.4.3.4-1: RACH Resource allocation bitmap

Field	Value	Definition
Reserved	NA	Reserved for future use. The field shall be ignored by the receiver.
Repeat	00	Resource allocation is single allocation, and the repetition and validity fields are not present. All values Coded as defined in Table 6.4.3.3-1.
	01	Resource allocation is repeated in the following frames with periodicity indicated in the Repetition field, until its validity expires, as indicated in the validity field.
	10	Resource allocation is repeated in the following subslots with periodicity indicated in Repetition field, until its validity expires, as indicated in the validity field.
	11	Reserved.
SFN		All values Coded as defined in Table 6.4.3.3-1.
Channel	0	The resource allocation(s) is valid for the channel where the IE is received. The channel field is not present in the IE.
	1	The channel where resource allocation(s) is valid is indicated in the channel field of the IE.
Chan_2	0	The random access response is sent on the same channel as the random access message.
	1	The separate channel field is included in the end of the IE to indicate the channel for Random access response message.

Start subslot: 8 bits or 16 bits. The start subslot indicates the first subslot where the RACH resource allocation is valid in the frame. The 8 bits version is used when $\mu \leq 4$, and the 16 bits version is used when $\mu > 4$, ETSI TS 103 636-3 [3].

Length type: 1 bit. As defined in clause 6.4.3.3.

Length: 7 bits. The length of the random access resource allocation in subslots or in slots.

MAX Len type: 1 bit. MAX RACH Length type. Similar as the Length type defined in clause 6.4.3.3.

MAX RACH Length: The maximum length of a single random access transmission.

CWmin_sig: 3 bits. Taking values: 0, 1, 2, 3 ..., 7. The configured $CW_MIN = 8 \times Cwmin_sig$.

DECT_Delay: 1 bit. If set to 0 the response window starts from the subslot $n+3$, where n indicates the subslot where the transmission of the Random Access packet ended. If set to 1 the response window starts 0,5 frames after the start of the frame where the Random access transmission was initiated.

Response window: Defines the response window length in subslots.

Cwmax_sig: 3 bits. Taking values: 0, 1, 2, 3 ..., 7. The configured $CW_MAX = 256 \times Cwmax_sig$.

Repetition: As defined in clause 6.4.3.3.

Validity: As defined in clause 6.4.3.3.

SFN offset: As defined in clause 6.4.3.3.

Channel: As defined in clause 6.4.3.3.

6.4.3.5 RD Capability IE

The RD Capability IE is used to indicate RD's capabilities to another RD. This IE is present in association request and association response messages. When RD in FT mode configures transmission and reception resources it shall not configure features not supported by the RD in PT mode. When an RD selects the physical layer transmission format it shall not exceed the capabilities of the receiving RD.

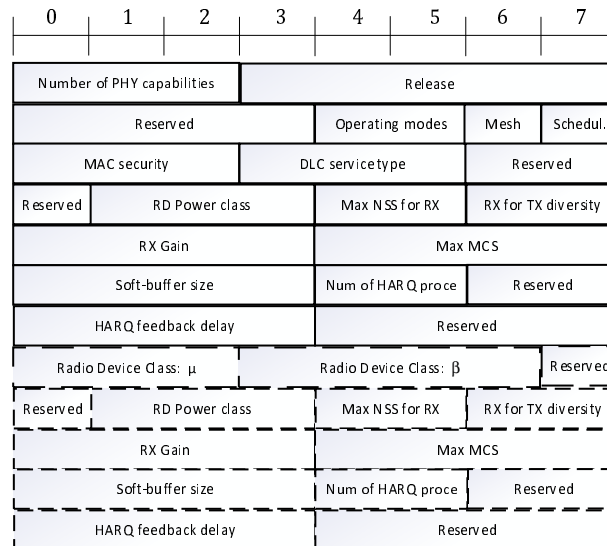

Figure 6.4.3.5-1: RD Capability IE

Table 6.4.3.5-1: RD Capability IE field definitions

Field	Bits	Definition
Number of Phy capabilities	3	Indicates the number of included physical layer capabilities. When set to 000, the device supports single numerology used in an existing connection. For additional physical layer numerologies the full capability is constructed from μ , β , followed by RD power class, max NSS for RX field and so on, resulting 5 octets PHY capability fields.
Release	5	Indicates release of the radio device. Coded values: reserved, Release 1, Release 2, Release 3, Release 4, rest of the values are reserved.
Operating modes	2	Indicates RD capability to support FT and PT mode of operation. Coded values: PT mode only, FT mode only, both FT mode and PT mode, reserved.
Mesh	1	Indicates RD capability to support mesh system operation. Coded values: not supported, supported.
Schedul.	1	Indicates RD capability to support scheduled data transfer service. Coded values: not supported, supported.
MAC security	3	Indicates RD capability to support MAC security. Coded values: not supported, Mode 1 supported, rest of the values are reserved.
DLC service type	3	Indicates RD capability to support DLC service types. Coded values: DLC Service type 0 supported, DLC Service type 1 supported, DLC Service type 2 supported, DLC Service type 3, type 2, and type 1 are supported, DLC Service types 0, 1, 2, 3 are supported, reserved.
RD Power Class	3	Indicates RD power as defined in ETSI TS 103 636-2 [2]. Coded as: Power class I, Power Class II, Power class III, the rest are reserved.
MAX NSS for RX	3	RD indicates the supported reception capability of spatial stream transmissions, as defined in ETSI TS 103 636-3 [3]. Coded Values: 1, 2, 4, 8, the rest are reserved.
RX for TX diversity	3	RD indicates the supported reception capability of the TX diversity transmission, as defined in ETSI TS 103 636-3 [3]. Coded Values: 1, 2, 4, 8, the rest are reserved.
RX Gain	4	RD indicates the supported receiver sensitivity capability in respect to reference sensitivity, as defined in ETSI TS 103 636-2 [2]. Coded Values: -10 dB, -8 dB, -6 dB, -4 dB, -2 dB, 0 dB, 2 dB, 4 dB, 6 dB rest are reserved.
MAX MCS	4	Maximum supported MCS for the reception. Coded Values: MCS2, MCS3, MCS4, MCS5, MCS6, MCS7, MCS8, MCS9, MCS10, MCS11, rest are reserved.
Soft-buffer size	4	Soft buffer size in bytes. Coded values: 16 000, 25 344, 32 000, 64 000, 128 000, 256 000, 512 000, 1 024 000, 2 048 000 bytes, rest are reserved.
Num. of HARQ proce	2	The number of parallel HARQ processes. Coded values: 1, 2, 4 or 8 processes.

Field	Bits	Definition
HARQ feedback delay	4	The processing time for creating the HARQ feedback in subslots. Coded values: 0, 1, 2, 3, 4, 5, 6 subslots.
μ	3	RD indicates the supported subcarrier scaling factor μ as defined in ETSI TS 103 636-3 [3]. Coded Values: 1, 2, 4, 8, rest are reserved.
β	4	RD indicates the supported Fourier transform scaling factor β as defined in ETSI TS 103 636-3 [3]. Coded Values: 1, 2, 4, 8, 12, 16, rest are reserved.

6.4.3.6 Neighbouring IE

The Neighbouring IE is used to indicate other RDs presence of neighbouring RD in FT mode. The IE is optional and can be multiplexed in unicast MAC PDUs or Network or Cluster beacon messages.

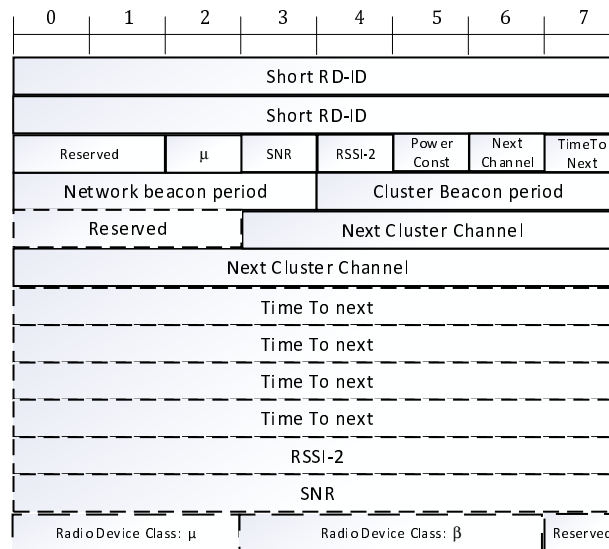

Figure 6.4.3.6-1: Neighbouring IE

Table 6.4.3.6-1: Neighbouring IE field definitions

Field	Bits	Definition
Short-RD ID	16	The Short-RD ID of the indicated RD.
μ	1	0: Radio device class signalling is not present. The indicated RD operates with same μ and β factor as the RD sending this IE. 1: Radio device class signalling is present. The indicated RD operates with the indicated μ and β factor.
SNR	1	0: SNR measurement result not present. 1: SNR measurement result, measured by the RD sending this IE, from indicated RD is present.
RSSI-2	1	0: RSSI-2 measurement result not present. 1: RSSI-2 measurement result, measured by the RD sending this IE, from indicated RD is present.
Power Const	1	Power constrain information from the indicated RD as defined in Table 6.4.2.2-1.
Next Channel	1	As defined in Table 6.4.2.3-1.
TimeToNext	1	As defined in Table 6.4.2.3-1.
Next Cluster Channel	13	Indicated RDs cluster beacon channel as defined in Table 6.4.2.2-1.
Time to next	32	Time until the start of the Indicated RDs cluster beacon period as defined in Table 6.4.2.2-1.

6.4.3.7 Broadcast Indication IE

The Broadcast indication IE is used to address an RD with a broadcast message, and it can be repeated multiple times in a MAC PDU. The Broadcast indication IE can be used for paging, or for random access response message. The IE can be included into a cluster beacon or transmitted in as broadcast message.

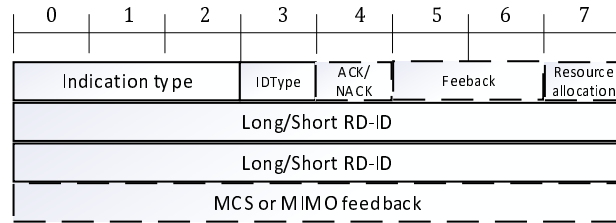

Figure 6.4.3.7-1: Broadcast Indication IE

Table 6.4.3.7-1: Broadcast Indication IE field definitions

Field	Bits	Definition
Indication type	3	Provides the type of the indication that is sent to all RDs listed in the IE. Value coding: Paging, Random access response. Other values are reserved.
IDType	1	Indicates the ID type used to identify different RDs. Value coding: Short RD-ID, Long RD-ID. For Random access response the Short RD-ID shall be used.
ACK/NACK	1	Present when the indication Type is Random access response. Otherwise, the field is set to reserved. 0: Indicates that the MAC PDU in a Random access transmission was incorrectly received. 1: Indicates that the MAC PDU in a Random access transmission was correctly received.
Feedback	2	Present when the indication Type is a Random access response. Otherwise, the field is set to reserved. Indicates the coding of the MCS or MIMO Feedback bits. Value coding: no feedback, MCS, MIMO_2_antenna, MIMO_4_antenna.
Resource Allocation	1	Indicates whether the resource allocation IE for the RD follows in this MAC PDU. 0: No present. 1: IE follows.
Long/Short RD-ID	16/32	Short RD-ID or Long RD-ID of an RD.
MCS or MIMO Feedback	8	If the Feedback field indicates the MCS, this field indicates the Channel quality indicator. The first 4 MSB bits are set to reserved and the 4 LSB bits contain the Channel quality, as defined in Table 6.2.2-3. If the feedback indicates the MIMO_2_antenna, this field provides MIMO feedback for two transmit antennas. The four MSB bits of the field are reserved. The fifth (5 th) MSB provides the number of layers: Single layer, dual layer. The 3 LSB bits provides the Codebook index as defined in Table 6.3.4-1 for single layer, or Table 6.3.4-3 for dual layer for dual layer as defined in ETSI TS 103 636-3 [3]. If the feedback indicates the MIMO_4_antenna, this field provides MIMO feedback for four transmit antennas. The two MSB bits of the field provides the number of layers: Single layer, dual layers, four layers, reserved. The 6 LSB bits provides the Codebook index as defined in Table 6.3.4-2 for single layer, or Table 6.3.4-4 for dual layers or Table 6.3.4-5 for four layers, as defined in ETSI TS 103 636-3 [3].

6.4.3.8 Padding IE

The Padding IE is used to fill up the MAC PDU to the next MAC PDU size supported by the physical layer, when other MAC messages, MAC IE or higher layer SDUs are not available or do not fit into the available space. The location of the padding IE is thus the last part of the MAC PDU or just before the MIC when the MAC security is used. When security is used the padding IE will be ciphered and used as part of the MIC calculation as any other IE. The receiver shall ignore the content of the padding IE.

Padding IE is used as follows:

- if one octet of padding is needed:
 - indicate in the MAC extension field: 11 (one bit length present), set length to zero and set IE type: 00000 (padding);
- else, if two octets of padding are needed:
 - indicate in the MAC extension field: 11 (one bit length present), set length to one and set IE type: 00000 (padding);
- else:
 - indicate in the MAC extension field: 01 (on octet length present), set IE type: 000000 (padding), and set the length to indicate the number of padding octets;
 - include the number of indicated octets of arbitrary data into the padding IE.

NOTE: When a receiver detects a MAC extension field: 01 and IE Type: 000000 or MAC extension field 11 and IE Type: 00000, the receiver can assume that the rest of the MAC PDU, except the MIC, is padding.

6.4.3.9 Group Assignment IE

The Group assignment IE is used to assign pre-configured resources to several RDs with a single broadcast message. The Group triggers the previously configured resource configuration to be valid after the indicated SFN offset and to be valid until the validity time expires, with the given repetition.

Single (1 bit): when set to 1 the bit indicates in the Group Assignment that there is only a single Resource Tag present and all the resource repetitions are assigned to a single RD. Otherwise the index of the Resource Tag present in the Group IE provides the index of the repeat resource.

For clarity the first Resource Tag, is the first instance of the configured resource allocation after the SFN offset, and the second Resource Tag is the first repetition and so on.

If the number of resource Tags is less than the number of resource repetitions in the resource allocation, those repetitions are considered as not assigned.

The Resource Tag value: 111 1111 (0x7F) is considered as broadcast and all members of the groups shall receive the given resource.

Direct (1 bit): indicates whether the direction of the pre-assignment resources is inverted.

When it is set to 0, the assignment follows the definition of Resource allocation IE in Table 6.4.3.3-1.

If Direct bit is set to 1 the direction is inverted.

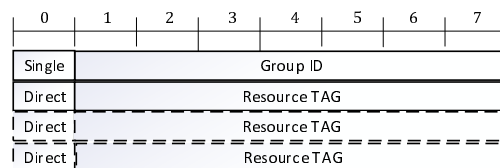

Figure 6.4.3.9-1: Group Assignment IE

Table 6.4.3.9-1: Group Assignment IE field definitions

Field	Bits	Definition
Single	1	0: Multiple resource assignments follows for a group. 1: Single resource assignment for the group member.
Group ID	7	Provides the Group ID for which the resource assignment is valid.
Direct	1	0: Indicates that the assignment follows the Resource allocation direction as defined in Table 6.4.3.3-1. 1: Indicates that the Resource allocation direction is inverted from the definition provided in Table 6.4.3.3-1.
Resource Tag	7	Provides the Resource Tag value. The index position of the Resource Tag indicated index to repeated resource which RD having the Tag value consider to be valid for it. Value: 111 1111 (0x7F) indicates that the resource is broadcast for all members of the group.

6.4.3.10 Load Info IE

An RD in FT mode may use a load info IE to indicate its operating load and the load of the current operating channel to the other RDs. The IE is optional and can be multiplexed with Network or Cluster beacon messages.

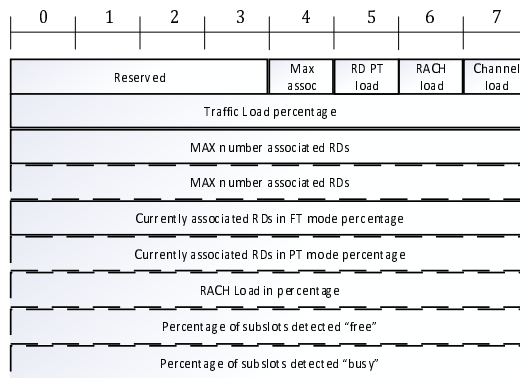

Figure 6.4.3.10-1: Load Info IE

Table 6.4.3.10-1: Load Info IE field definitions

Field	Bits	Definition
Max assoc	1	0: MAX number of associated RDs is an 8 bit field. 1: MAX number of associated RDs is a 16 bit field.
RD PT load	1	0: Currently associated RDs in PT mode percentage field is not present. 1: Currently associated RDs in PT mode percentage field is present.
RACH load	1	0: RACH Load percentage field is not present. 1: RACH Load percentage field is present.
Channel Load	1	0: Percentage of slots detected "free" and Percentage of slots detected "busy" fields are not present. 1: Percentage of slots detected "free" and Percentage of slots detected "busy" fields are present.
Traffic Load percentage	8	Current traffic load percentage from the maximum traffic load that can be routed by the RD in FT mode. Includes both own data and data from other devices to be routed forward. Value 0x0 means 0 % load and 0xFF means 100 % load.
MAX number associated RDs	8 or 16	Maximum number of allowed associated devices with an integer value.
Currently associated RDs in FT mode	8	Number of associated RDs in FT mode with a percentage value. Value 0x0 means 0 % and 0xFF means 100 %.
Currently associated RDs in PT mode	8	Number of associated RDs in PT mode with a percentage value. Value 0x0 means 0 % and 0xFF means 100 %.
RACH Load in percentage	8	Percentage of used RACH resources from all the configured RACH resources. Value 0x0 means 0 % load and 0xFF means 100 % load.
Percentage of subslots detected "free"	8	Percentage of subslots detected as "free" as defined in clause 5.1.2. Value 0x0 means 0 %, no "free" subslots have been detected and 0xFF means 100 % of the slots are detected as "free".
Percentage of subslots detected "busy"	8	Percentage of subslots detected as "busy" as defined in clause 5.1.2. Value 0x0 means 0 % no "busy" slots have been detected and 0xFF means 100 % of the measured subslots are detected as "busy".

6.4.3.11 Configuration Request IE

The configuration request IE, has zero length and it is used by an RD in PT mode to request system configuration parameters from an RD in FT mode. The IE is optional and can be multiplexed with other messages or data in the MAC PDU.

A typical case for sending configuration request IE is when an RD has not received a cluster beacon message at the expected time. When an RD in FT mode receives the configuration request IE, it should respond with a unicast transmission of a cluster beacon message, clause 6.4.2.4, and optionally with a route info IE, clause 6.4.3.2, and a load info IE, clause 6.4.3.10.

6.4.3.12 Measurement Report IE

The measurement report IE is used by an RD in PT mode to report measured RSSI-2, SNR, and RSSI-1 values from the scheduled resources or RACH response messages to the RD in FT mode. Further, RD may report, the number of transmission attempts made at the transmitter side to transmit a MAC PDU in the TX count result field.

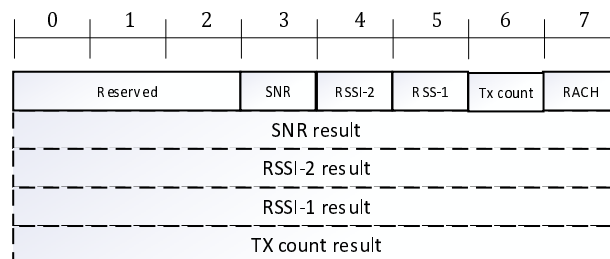

Figure 6.4.3.12-1: Measurement report IE

Table 6.4.3.12-1: Measurement Report IE field definitions

Field	Bits	Definition
SNR	1	0: SNR result field containing SNR measurement results not present. 1: SNR measurement result present.
RSSI-2	1	0: RSSI-2 result field containing RSSI-2 measurement results not present. 1: RSSI-2 result field containing RSSI-2 measurement result present.
RSSI-1	1	0: RSSI-1 result field containing RSSI-1 measurement results not present. 1: RSSI-1 result field containing RSSI-1 measurement result present.
Tx count	1	0: Tx count result field containing Tx count measurement results not present. 1: Tx count result field containing Tx count measurement result present.
RACH	1	0: Measurement result obtained from DL scheduled resources. 1: Measurement result obtained from DL reception of Random access response.
SNR result	8	SNR measurement result, value code as defined in ETSI TS 103 636-2 [2].
RSSI-2 result	8	RSSI-2 measurement result, value code as defined in ETSI TS 103 636-2 [2].
RSSI-1 result	8	Averaged RSSI-1 measurement results over the measured resource, value code as defined in ETSI TS 103 636-2 [2].
TX Count result	8	The number of transmission attempts made at the transmitter side to transmit a MAC PDU. Considers possible CCA failures, as well as HARQ and ARQ re-transmissions attempts. Value 0xFF indicates that transmission of a MAC PDU has completely failed.

6.4.3.13 Radio Device Status IE

The Radio device status IE is used by an RD in FT mode to report memory full condition or return to normal operation. When RD in PT mode receives this IE status flag set 01, it indicates, that RD FT mode is not able to process any new MAC PDU during the time indicated in the duration field. When RD in PT mode receives this IE with the status flag set 10, it indicates that the RD in FT mode has returned to normal operation and abnormal operation has ended. The duration field indicates the time that the abnormal operation has taken.



Figure 6.4.3.13-1: Radio Device Status IE

Table 6.4.3.13-1: Radio Device Status IE field definitions

Field	Bits	Definition
Status flag	2	00: Reserved. 01: Memory Full. 10: RD in FT mode has returned to normal operation. 11: Reserved.
Duration	4	When the status flag is set to 01, the duration gives the estimated time for memory full is lasting in the RD FT. When the status flag is set to 10, the duration gives the time to how long the abnormal operation lasted in the RD FT. Coding of the IE: 50 ms, 100 ms, 200 ms, 400 ms, 600 ms, 800 ms, 1 000 ms, 1 500 ms, 2 000 ms, 3 000 ms, 4 000 ms, unknown, rest are reserved.

7 Variables, and Timers

7.1 General

Variables, and timers are general and shall be applied in all operating bands.

The set of variables, constants and timers are operating band specific values and shall be applied on each indicated band with band specific values. The use of these variables, constants and timers on other bands is not prohibited.

7.2 Variables

Table 7.2-1: Channel selection and Mobility variables

Variable	Default value on Operating Band 1 in ETSI TS 103 636-2 [2]	Default value on other Operating Bands in ETSI TS 103 636-2 [2]	Definition
<i>DECT_PROTECTED</i>	TRUE	NA	Defines when specific channel selection rules apply.
<i>SCAN_MEAS_DURATION</i>	24 slots	NA	The minimum measurement time for a single operating channel to obtain RSSI-1 value for each measured subslot.
<i>RSSI_THRESHOLD_MIN</i>	-85 dBm	NA	The RSSI-1 threshold when a slot is detected as "free".
<i>RSSI_THRESHOLD_MAX</i>	-52 dBm - MAX TX power of the RD	-40 dBm - MAX TX power of the RD	The RSSI-1 threshold when a slot is detected as "busy".
<i>SCAN_SUITABLE</i>	75 %	NA	Threshold when an operating channel can be considered fulfilling the operating conditions.
<i>CHANNEL_LOADED</i>	80 %	NA	Threshold when an operating channel load is so high that the RD should start Operating Channel(s) and Subslot(s) selection.
<i>SCAN_MEAS_START</i>	8 s	NA	Defines the duration how long the Channel load is evaluated.
<i>NETWORK_BEACON_PRERIOD</i>	Always signalled	Always signalled	Defines the Network Beacon transmission period of an RD in FT mode.
<i>CLUSTER_BEACON_PERIOD</i>	Always signalled	Always signalled	Defines the Cluster Beacon transmission period of an RD in FT mode.
<i>COUNT_TO_TRIGGER</i>	Always signalled	Always signalled	Defines the threshold of how many times the target RD in FT mode needs to be measured better than the current FT for a mobility event.
<i>REL_QUALITY</i>	Always signalled	Always signalled	Defines the relative quality that the target RD in FT mode needs to be better than the current FT for a mobility event.
<i>MIN_QUALITY</i>	Always signalled	Always signalled	Defines the minimum quality above sensitivity that an RD in FT mode needs to be for the association.
<i>NEXT_CLUSTER_CHANNEL</i>	Always signalled	Always signalled	Defines the next cluster channel of an RD in FT mode.

Table 7.2-2: Random Access variables

Variable	Default value on Operating Band 1 in ETSI TS 103 636-2 [2]	Default value on Operating Band in ETSI TS 103 636-2 [2]	Definition
<i>CW_CURRENT</i>	Dynamic	Dynamic	Defines the current upper edge of the window where a random delay for an initiating RACH transmission is selected.
<i>CW_MAX</i>	Always signalled	Always signalled	The maximum upper edge of the window where a random delay for an initiating RACH transmission is selected.
<i>CW_MIN</i>	Always signalled	Always signalled	The minimum upper edge of the window where a random delay for initiating a RACH transmission is selected.
<i>MINIMUM_LBT_PERIOD</i>	Duration of STF plus GI	Duration of STF plus GI	Defines the minimum LBT time that a channel needs to be measured free before initiating a transmission.

7.3 Timers

Table 7.3-1: Timers

Timer	Value on Operating Band 1 in ETSI TS 103 636-2 [2]	Value on Operating Band in ETSI TS 103 636-2 [2]
<i>dectProTime</i>	Beacon transmissions and Resources announced for random access transmission: Cluster beacon period. Resources to be allocated for scheduled access transmissions: 800 ms	NA
<i>scanStatusValid</i>	300 s	600 s
<i>rachBackOff</i>	Dynamic	Dynamic
<i>countToTrigger</i>	Always signalled	Always signalled
<i>timeToNext</i>	Always signalled	Always signalled
<i>dectScheduledResourceFailure</i>	Default value 2 seconds Other values signalled	Default value 2 seconds Other values signalled

Annex A (normative): MAC Layer Requirements for Radio Device Capabilities

A.1 Introduction

Radio device capabilities define a set of MAC functionalities that are supported by the RD.

A.2 Radio Device Capabilities

A.2.0 Release

The RD shall set the field to Release 1 in the Release field in RD capability IE.

A.2.1 Operating Modes

An RD may support FT mode or PT mode or operation in FT mode and PT mode simultaneously.

When supporting operation in FT mode, the RD shall support the transmission of Network Beacon and Cluster Beacon messages.

RD uses the Operating modes field in RD capability IE to indicate operating mode support.

A.2.2 System Operation

An RD may support Mesh system operation, including transmission and reception of Route Info IE.

RD uses the Mesh field in RD capability IE to indicate the support mesh system operation.

In case RD is indicating support operation in FT mode and PT mode simultaneously in operating modes, the RD shall also indicate support of Mesh.

A.2.3 Security

An RD may support MAC Security Mode 1.

RD uses the MAC security field in RD capability IE to indicate the support MAC Security Mode 1.

A.2.4 Scheduled data transfer service

An RD may support scheduled data transfer service.

RD uses the Schedul. field in RD capability IE to indicate the support scheduled data transfer service.

A.2.5 Feedback Info Formats

An RD shall support Feedback Info Format 1, Feedback Info Format 2, and Feedback Info Format 3 when supporting single MAX NSS for RX streams.

An RD shall support Feedback Info Format 5, when supporting MAX NSS for RX higher than 1.

An RD supporting 8 HARQ process shall support Feedback info format 4.

A.2.6 HARQ feedback delay

An RD may support different HARQ feedback processing times.

RD uses the HARQ feedback delay field in RD capability IE to indicate the support HARQ feedback processing time for each supported physical layer μ and β configuration.

Annex B (normative):
Void

Annex C (informative): Change History

Date	Version	Information about changes
July 2020	1.1.1	First publication of the TS
December 2020	1.1.2	Implemented Change Requests: DECT(20)000330r2 Small corrections to ETSI TS 103 636-4 DECT(20)000349r2 Clarification on bit encoding of PHY header ETSI TS 103 636-4 DECT(20)000360 Security IE and routing IE correction These CRs were approved DECT#88 Version 1.1.2 prepared by the Rapporteur
April 2021	1.2.1	Second publication of the TS
June 2021	1.2.2	Implemented Change Requests: DECT(21)000148r1 : Clarification on Integrity protection DECT(21)000147r1 : Optimization PHY Feedback coding in MAC DECT(21)000133r2 : Signalling Maximum TX power of the cluster
September 2021	1.2.3	Implemented Change Requests: DECT(21)000220 : Introduction Power Const bit and Current Cluster Channel into Association Request in TS103 636-4 DECT(21)000222 : Introduction of Configuration Request IE in ETSI TS 103 636-4 DECT(21)000223r1 : Introduction of Load Info IE in ETSI TS 103 636-4 DECT(21)000225r1 : Taking into account new Part 5 in ETSI TS 103 636-4
October 2021	1.2.4	Implemented Change Requests: DECT(21)000242 : Editorial corrections to ETSI TS 103 636-4
November 2021	1.2.5	Implemented Change Requests: DECT(21)000275r1 Simplification on Padding IE processing DECT(21)000267 Processing optimization on Initialization vector Clause: Foreword, updated with common text used other parts
December 2021	1.3.1	Second publication
July 2022	1.3.2	Implemented Change Requests: DECT(22)000135 : Correcting RACH response and editorial improvements and corrections DECT(22)000157r1 TS 103 636 4 MAC Editorial Corrections
September 2022	1.3.3	Implemented Change Requests: DECT(22)095017r2 : Avoid deterministic collision in deferred random access transmissions
November 2022	1.3.4	Implemented Change Requests: DECT(22)000253r3 : Improvements to scheduled access data transfer procedures DECT(22)000243r1 : Removing Last minute scan from RACH transmission DECT(22)000257r2 : RD capability signalling DECT(22)000267r2 : Improving MAC error recovery
December 2022	1.3.5	Implementing Change Request: DECT(22)000258 : Editorial updates to TS103.636-4
December 2022	1.3.6	Implementing Change Request: DECT(22)000280 : Correcting HARQ feedback delay capability

History

Document history		
V1.1.1	July 2020	Publication
V1.2.1	April 2021	Publication
V1.3.1	December 2021	Publication
V1.4.1	January 2023	Publication